

---

---

# STANLEY®

---

---

## HAND TOOLS & STORAGE

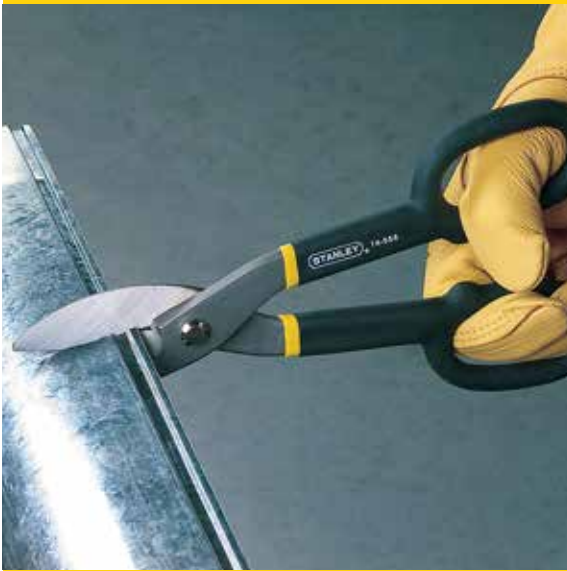

[www.stanleytoolsindia.com](http://www.stanleytoolsindia.com)

**PRICE LIST (MRP)**  
w.e.f 1st February 2022

# StanleyBlack&Decker

**A LEADING GLOBAL DIVERSIFIED INDUSTRIAL**  
BASED ON REVENUE

# #1

**IN TOOLS &  
STORAGE**

# #2

**IN SECURITY  
SERVICES**

# GLOBAL LEADER

**IN ENGINEERED  
FASTENING**

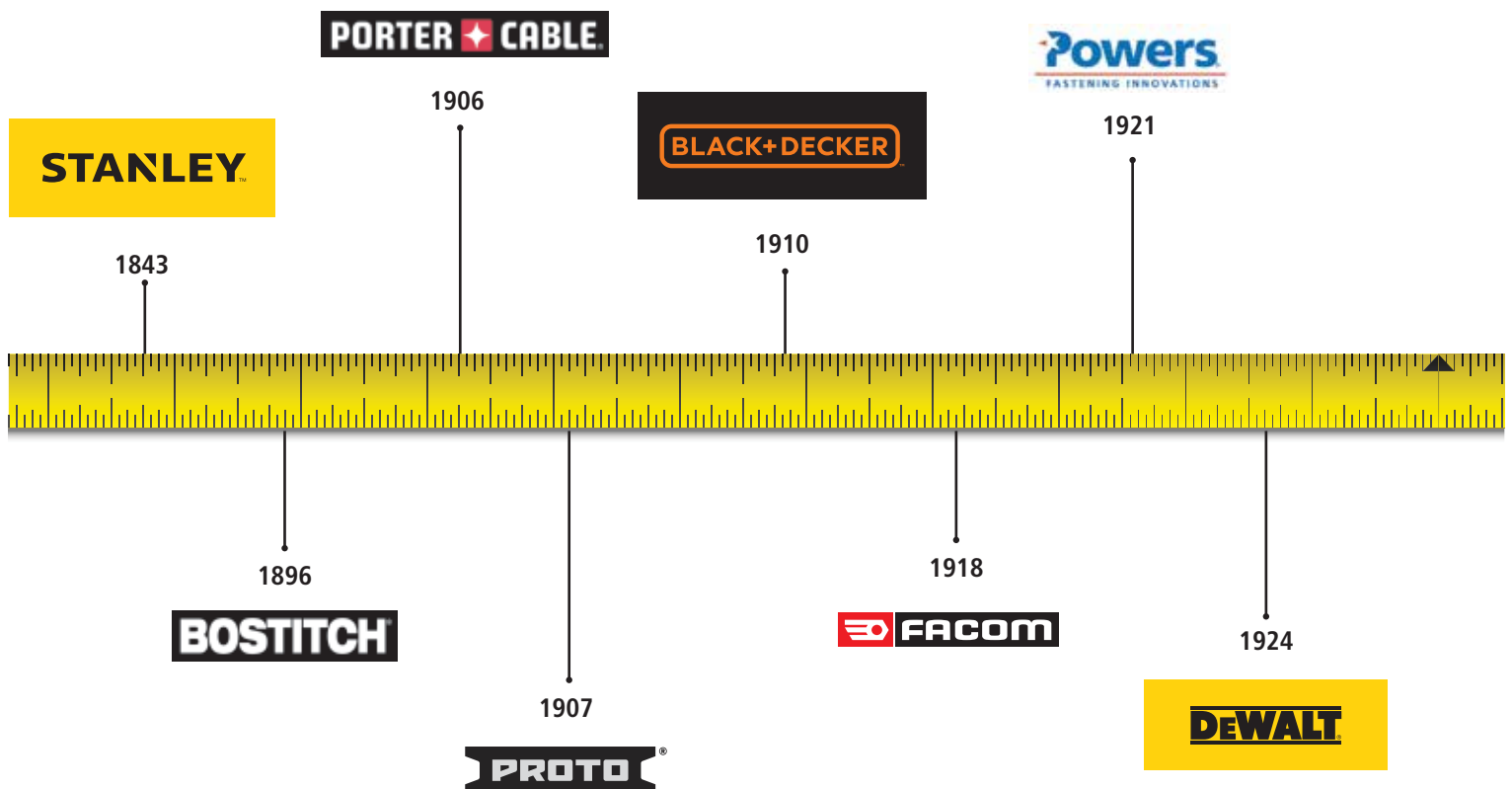

**A FORMIDABLE LEGACY.**





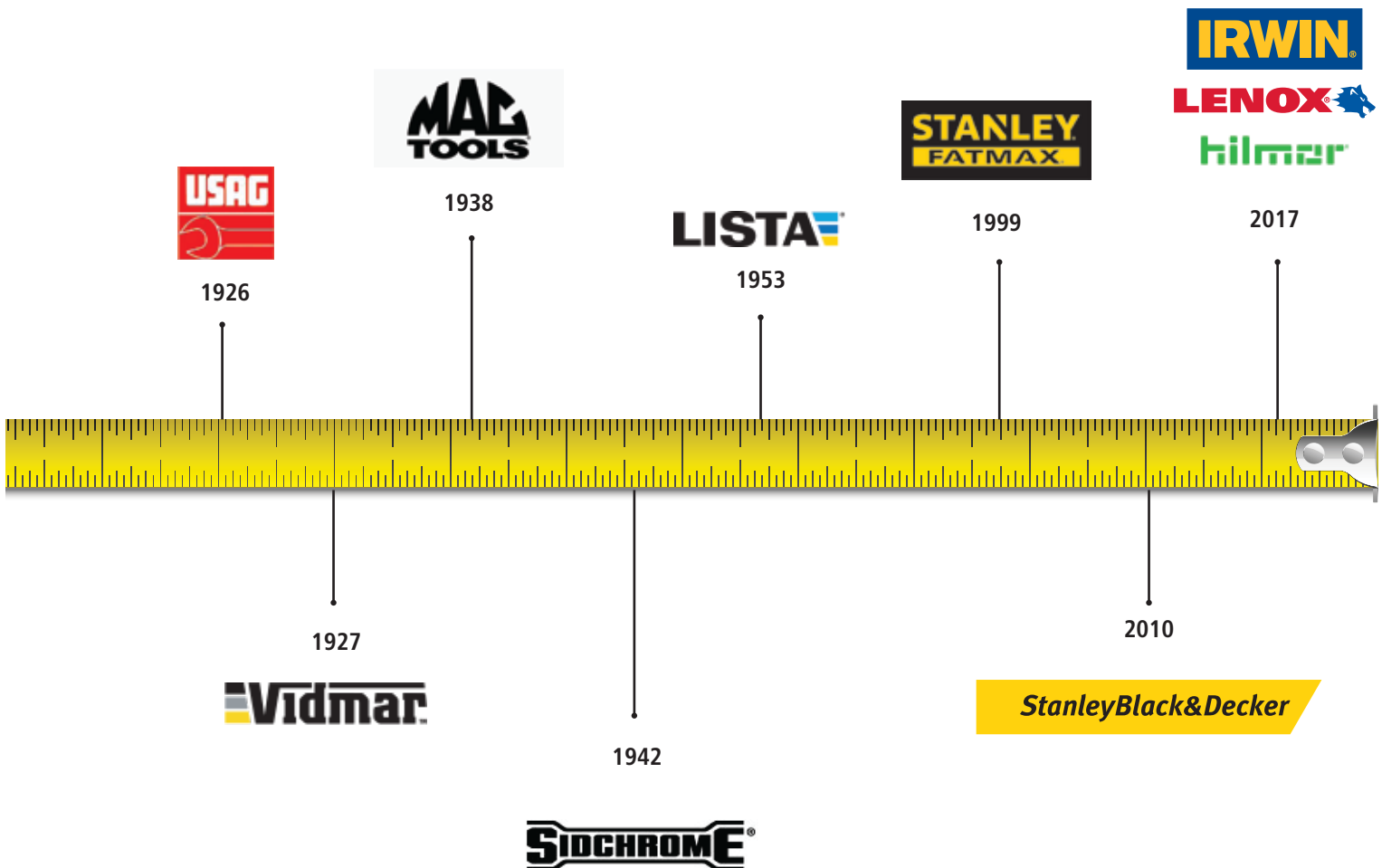











# 178 YEARS

For the builders and protectors, for the makers and explorers, for those shaping and reshaping our world through hard work and inspiration, Stanley Black & Decker provides the tools and innovative solutions you can trust to get the job done — and we have since 1843.



A POWERFUL FUTURE.



	<b>TOOL SETS</b>	<b>01 - 04</b>		<b>SPECIALTY TOOLS</b>	<b>27 - 28</b>
	MASTER TOOL SETS MULTI-TOOL SETS HONDA TOOL KIT HOME TOOL KIT TRADESMEN KIT			3 JAW PULLER FEELER GAUGE, OIL FILTER WRENCH SCREW EXTRACTOR BOTTLE JACKS, TYRE REPAIR KIT, FOOT PUMP, & 2T AXLE STANDS	
	<b>SPANNER &amp; SETS</b>	<b>05 - 08</b>		<b>INSULATED TOOLS</b>	<b>29</b>
	DOE, RING, COMBINATION SPANNERS/ SETS, ADJUSTABLE WRENCHES, T-HANDLE SPANNERS, PIPE WRENCHES, OPEN/RING END SLOGGING SPANNERS			VDE SCREWDRIVERS SET, COMBINATION/CUTTING/NOSE PLIERS WATER PUMP PLIER VDE PLIER SETS	
	<b>PLIERS</b>	<b>09 - 11</b>		<b>OPTICAL LEVELS &amp; ELECTRONIC DEVICES</b>	<b>30 - 33</b>
	COMBINATION/CUTTING PLIERS, 12-IN-1 MULTITOO, NOSE PLIERS, CIRCLIP/CRIMPING PLIERS, WATER PUMP PLIERS/JOINT PLIERS, LOCKING PLIERS			AUTOMOMATIC OPTICAL LEVELS & ACCS. LASER DISTANCE MEASURERS LASER LEVELS, STUD FINDER & DETECTORS MOISTURE METER, THERMOMETER	
	<b>SCREWDRIVERS &amp; KEYS</b>	<b>12 - 14</b>		<b>MEASURING &amp; LAYOUT TOOLS</b>	<b>34</b>
	CUSHION GRIP SCREWDRIVERS/SETS, PVC SCREWDRIVERS PH/SLOTTED, SPECIALITY SCREWDRIVERS & TESTERS, TORX, HEX, T-HANDLE KEYS/SETS			MEASURING TAPE, MEASURING WHEEL, TORPEDO, BOX, I-BEAM LEVELS CHALK LINE LEVEL	
	<b>FASTENING TOOLS</b>	<b>15</b>		<b>CUTTING TOOLS</b>	<b>35 - 37</b>
	GLUE GUNS CORDED/CORDLESS, GLUE STICKS, SOLDERING IRON, STAPLE GUN, RIVETERS			RETRACTABLE UTILITY KNIVES & BLADES SNAP-OFF KNIVES & BLADES, WRAP CUTTER HACKSAW, GLASS CUTTER, BOLT, CABLE, & PIPE CUTTER, SNIPS WOODWORKING PLANES	
	<b>SOCKETS, SETS, &amp; SOCKET ACCESSORIES</b>	<b>16 - 21</b>		<b>STRIKING TOOLS</b>	<b>38</b>
	1/4", 3/8", 1/2", & 3/4" DR SOCKET SETS, SOCKETS, IMPACT SOCKETS & SETS, SOCKET ACCESSORIES			HAMMERS CHISELS & PUNCHING KITS CAMP AXE, COLD CHISEL CENTER PUNCH	
	<b>TORQUE WRENCHES</b>	<b>22 - 23</b>		<b>CLAMPING TOOLS</b>	<b>39</b>
	1/4" & 3/8" TORQUE WRENCHES 1/2" TORQUE WRENCHES 3/4" TORQUE WRENCHES BRITOOOL - 3/8", 1/2", 3/4" & 1" DR TORQUE WRENCHES			C-CLAMPS F-CLAMPS BAR CLAMPS & VICES	
	<b>IMPACT WRENCHES &amp; AIR RATCHETS</b>	<b>24 - 26</b>		<b>STORAGE</b>	<b>40 - 44</b>
	1/2" IMPACT WRENCHES 3/4" IMPACT WRENCH 3/8" IMPACT WRENCH 3/8" & 1/2" AIR RATCHETS			METAL STORAGE & PLASTIC TOOL BOX TSTAK SOFT STORAGE TOOL VEST & APRON	

## Terms & Conditions:

1. These are current prices and supersede all previous price lists.
2. Prices are subject to revision without prior notice and all pending orders, if any will be invoiced at the rates prevailing on the date of delivery.
3. All prices are Maximum Retail Prices and are inclusive of GST.

**TOOL SETS**  
**MULTI-TOOL SETS**  
**150PC MASTER TOOL SET**



HSN CODE: 82060010

PART No.	DESCRIPTION	MOQ	MRP
94-181	150PC MASTER TOOL SET	1	30,917

- 10 PC 1/4 Drive 6 Point Socket: 5/32, 3/16, 7/32, 1/4, 9/32, 5/16, 11/32, 3/8, 7/16, 1/2
- 10PC 1/4 Drive 6 Point Metric Sockets: 4,5,6,7,8,9,10,11,12,13mm
- 6 PC 1/4 Drive 6 Point Metric Deep Socket: 4,5,6,7,8,9mm
- 3 PC 3/8 Drive Phillips® Bit Socket #1, #2, #3
- 9 PC 3/8 Drive 6 Point Socket: 3/8,7/16,1/2,9/16,5/8,11/16,3/4,13/16,7/8
- 6 PC 3/8 Drive 6 Point Metric Deep Sockets:10,11,12,13,14,15mm
- 2 PC 3/8 Drive Extension Bar-Locking : 3,6(76,152mm)
- 2 PC 3/8 Drive Spark Plug Metric Sockets, 16,21mm
- 8 PC 3/8 Drive 6 point Torx® Sockets : E 8,E 10,E 11,E 12,E 13,E 14,E 15,E 16,E 18,E 20
- 11 PC 3/8 Drive 6 Point Metric Sockets: 9,10,11,12,13,14,15,16,17,18,19mm
- 4 PC 1/2 Drive Impact 6 Point Metric Sockets: 17,19,21,23mm
- 4 PC 1/2 Drive 12 Point Sockets: 15/16, 1, 1-1/16, 1-1/4
- 7 PC 1/2 Drive 12 Point Sockets: 20,21,22,24,27,30,32mm
- 6 PC 3/8 Drive Hex Bit Socket 3,4,5,6,8,10mm
- 3 PC 3/8 Drive Pozidrive Bit Sockets: #1,#2,#3
- 12 PC Full Polish long Panel Combination Wrenches;  
8,9,10,11,12,13,14,15,16,17,18,19mm
- 3 PC Double Box Reversal Metric Ratcheting Wrenches: 8x9,12x13,17x19mm
- 7 PC 1/4 Drive Trox (Hole) Bit: T-10,T-15, T-20, T-27, T-30, T-40
- 10 PC Hex Key: 1.5, 2.0, 2.5, 3.0, 4,5,6,7,8,10mm
- 1 PC 1/4 Drive Pear Head Ratchet With Comfort Grip
- 1 PC 1/4 Drive Extension Bar 100mm
- 1 PC 1/4 Spinner Handle
- 6 PC 1/2 Drive Deep 6 Point Metric Socket: 10, 12, 13, 14, 17, 19mm
- 2 PC 1/2 Drive Extension Bar: 5,10(125, 150mm)
- 3 PC 3/8 Drive Slotted Bit Sockets: 4, 5.5, 6.5mm
- 7 PC 3/8 Drive Trox® Bit Sockets: T-20, T-30, T-40, T-45, T-50, T-55, T-60
- 1 PC 1/4 Drive Universal Joint
- 1 PC 1/4 Drive Adapter
- 1 PC 3/8 Drive Universal Joint
- 1 PC 3/8 Drive Pear Head Ratchet With Comfort Grip
- 1 PC 1/2 Drive Pear Head Ratchet With Comfort Grip
- 1 PC 1/2 Drive Universal Joint

**132PC METRIC & A/F TOOL KIT**



HSN CODE: 82059030

Old PART No.	PART No.	DESCRIPTION	MOQ	MRP
99-059-12	99-059	132PC METRIC & A/F TOOL KIT	1	27,150

- 33 PC Assorted 1/4" Bits, Screwdriver, Hex and Torx®
- 33 PC 1/2" Drive Standard Socket: Metric:  
10,11,12,13,14,15,16,17,18,19,20,21,22,23,24,27,30,32mm A/F:  
3/8,7/16,1/2,9/16,5/8,11/16,3/4,13/16,7/8,15/16,1,1-1/16,1-1/8,1-3/16,1-1/4"
- 19 PC Combination Spanners: Metric: 8,9,10,11,12,13,14,15,16,17,18,19mm A/F:  
3/8,7/16,1/2,9/16,5/8,11/16,3/4"
- 16 PC 1/4" Drive Standard Socket: Metric: 4,4.5,5,5.5,6,7,8,9,10mm A/F:  
3/16,7/32,1/4,9/32,5/16,11/32,3/8"
- 9 PC Hex Key Set-Long Ball Type: 1.5,2,2.5,3,4,5,6,8,10mm
- 6 PC 1/2" Drive Socket Accessories: Heavy Duty Ratchet, 75, 125 and 125mm Extensions, Universal Joint, Flex Bar
- 6 PC 1/4" Drive Socket Accessories: Heavy Duty Ratchet, 50 and 150mm Extensions, Universal Joint, Socket Driver, Bit Holder
- 4 PC Screwdrivers: Slotted 5x100mm, 6x150mm Philips® # 1x100mm, # 2x150mm
- 2 PC 1/2" Drive Spark Plung Socket: 5/8 and 13/16"
- 1 PC Adjustable Wrench: 300mm
- 1 PC 152mm Diagonal Cutting Pliers 1 PC 152mm Long Nose Pliers
- 1 PC 178mm Combination Pliers

**120PC MASTER TOOL SET**



HSN CODE: 82060010

OLD PART No.	PART No.	DESCRIPTION	MOQ	MRP
91-931-12	91-931	120PC MASTER TOOL SET	1	14,220

- 17Pc 3/8 Drive 6 Point Bit Socket: Torx®: T20,T30,T40,T45,T50,T55,T60
- Hex : 3,4,5,6mm, Phillips® :1 Pt, 2Pt, POZIDRIVE®: 1 Pt,2 Pt, Slotted: 5.5,6,5mm
- 12 Pc 1/4 Drive Socket 6 Point: 4,5,5.5,6,6.5,7,8,9,10,11,12,13mm
- 11 Pc 3/8 Drive Socket 6 Point: 9,10,11,12,13,14,15,16,17,18,19mm
- 10 Pc 1/4 Drive Socket 6 Point: 5/32,3/16,7/32,1/4,9/32,5/16,11/32,3/8,7/16,1/2
- 10 Pc Full Polish Long Panel Combination Wrenches: 9,10,11,12,13,14,17,18,19mm
- 9 Pc 3/8 Drive Socket 6 Point : 3/8,7/16,1/2,9/16,5/8,11/16,3/4,13/16,7/8
- 8 Pc 3/8 Drive Torx® Socket: E8,E10,E11,E12,E14,E16,E18,E20
- 7 Pc 1/2 Drive Socket 6 Point: 20,21,22,24,27,30,32mm
- 7 Pc 3/8 Drive Torx® (Hole) Bits: T10,T15,T20,T25,T27,T30,T40
- 4 Pc 1/4 Drive Deep Socket 6 Point: 8,9,10,12mm
- 4 Pc 3/8 Drive Deep Socket 6 Point: 13,14,15,17mm
- 4 Pc 1/2 Drive Socket 6 Point: 15/16, 1, 1-1/16, 1-1/4
- 4 Pc 1/2 Drive Impact Socket 6 Point: 14,19,21,23mm
- 3 Pc Universal Joint: 1/4,3/8,1/2
- 3 Pc Pear Head Ratchet: 1/4,3/8,1/2
- 2 Pc 3/8 Drive Extension Bar: 3,10 (75,250mm)
- 2 Pc 1/2 Drive Extension Bar: 5,10 (125,250mm)
- 2 Pc 3/8 Drive Spark Plung Socket 6 Point: 16,21mm
- 1 Pc 1/4 Drive Bit Adapter: 1/4
- 1 Pc 1/4 Drive Spanner
- 1 Pc 1/4 Drive Extension Bar: 2 (50mm)

**110PC MULTI TOOL SET**



HSN CODE: 82041120

PART No.	DESCRIPTION	MOQ	MRP
STMT81243	110PC MULTI TOOL SET	1	11,296

- 1 PC Diagonal Cutting Plier 6"
- 1 PC Long Nose Plier 8"
- 1 PC Groove Joint Pliers 10"
- 2 PC Slotted Screwdrivers: 5.5 X 75mm, 6.5 X100mm.
- 2 PC Philips Screwdriver: Ph1 X 75mm, Ph2 X100mm.
- 1 PC 1/4" Bit Adapter Ratcheting Screwdriver.
- 40 Bits – Slotted Bits: 3.5 X 2, 2 X 4, 5.5, 6.5, 8 Mm.
- Square Bits: S1, S2 And S3.
- Phillips Bits: Ph0 X 2, Ph1 X 2, Ph2 X 2, Ph3 X 2.
- Adaptors (2 Parts).
- Torx Bits: T10, T15, T20, T25, T27, T30, T40.
- Pozidriv Bits: Pz1, Pz2, Pz3.
- Tri-wing Bits: 1, 2, 3, 4
- Hexagonal Bits: 2, 3, 4, 5, 6, 7 Mm.
- 1 PC 1/4" Flexible Extension 100mm-"1/4"(M)X1/4"(F).
- 1 PC 1/4" Extension 50mm
- 1 PC 1/4" Extension 100mm
- 1 PC 1/2" Extension 125mm
- 1 PC 1/2" Extension 250mm
- 1 PC 1/2" 3 Way Adaptor
- 1 PC 1/4" Universal Joint
- 1 PC 1/2" Universal Joint
- 1 PC 1/2" Spark Plug Sockets 16 Mm
- 1 PC 1/2" Spark Plug Sockets 21 Mm
- 1 PC 1/4" Ratchet With Quick Release Button 72t
- 1 PC 1/2" Ratchet With Quick Release Button 72t
- Combination Wrenches: 8-15,17,18,19 Mm
- 8PC Hex Key Set: 1.5, 2, 2.5, 3, 4, 5, 5.5, 6 Mm
- 1/2" 6pt Socket: 10-15, 17, 18, 19, 20-24, 27 Mm
- 1/4" 6pt Socket: 4, 5, 6, 7, 8, 9, 10, 11, 12, 13, 14 Mm
- 1 Hex Key Rack, 4 Bit Racks.

### 53PC TELECOMMUNICATION SET



HSN CODE: 82060010

PART No.	DESCRIPTION	MOQ	MRP
TELECOM-KIT	53PC TELECOMMUNICATION SET	1	16,885

- 13 Pc 1/4" dr. Drive 6 Point Socket: 4,4.5,5,5.5,6,7,8,9,10,11,12,13,14mm
- 10 Pc Hex Keys: 1.5,2,2.5,3,4,5,5.5,6,8,10mm
- 8 Pc Cushion Grip Screwdriver: Ph1\*75mm and 150mm, Ph2\*45mm and 100mm
- 3\*75mm and 150, 6.5\*40mm and 100mm
- 6 Pc Precision Screwdrive Set: Opt, 1pt, 1.4mm, 2.0mm, 2.4mm, 3.0mm
- 1 Pc Standard Digital Multi Meter
- 1 Pc Utility Knife
- 1 Pc 6" Long Nose Pliers; 1 Pc 8" Linensman Pliers
- 1 Pc Mini-hacksaw; 1 Pc 10" Adjustable Wrench
- 1 Pc 9" Wire Stripper; 1 Pc Spinner Handle
- 1 Pc 1/4" Dr. Drive Adaptor; 1 Pc Soldering Iron 40w/22v
- 1 Pc Solder; 1 Pc Desoldering Pump 94-380
- 1 Pc Digital Spark Tester; 1 Pc Tweezers
- 1 Pc Measuring Tape-3M; 1 Pc Plastic Box



### HONDA 2-WHEELER TOOL KIT



HSN CODE: 82059030

PART No.	DESCRIPTION	MOQ	MRP
HONDA TL-KIT	HONDA TOOLS KIT	1	15,089

- 1 PC 70-938E Combination Spanner, 8mm
- 1 PC 70-940E Combination Spanner, 10mm
- 1 PC 70-942E Combination Spanner, 12mm
- 1 PC 70-944E Combination Spanner, 14mm
- 1 PC 70-947E Combination Spanner, 17mm
- 1 PC STMT87434-8 Adjustable Wrench, 300mm-12"
- 1 PC 70-379E Double Ended Open Spanner; 8PC. Set 6x7- 20x22mm
- 1 PC 70-375E Double Ended Open Jaw Crv Spanner 24x27mm
- 1 PC 70-377E Double Ended Open Jaw Crv Spanner 30x32mm
- 1 PC 54-114 Ball Pein Hammer 450gms - 16 Oz
- 1 PC STMT69213-8 Metric Hex Key Set-ring, 10 PC
- 1 PC 70-395E Shallow Offset Ring Spanner Set 6x7-30x32mm
- 1 PC 70-461 Comb Plier Single Color Sleeve, 205mm-8"
- 1 PC 84-096-23 Miniature Plier, Needle Nose, 127mm-5"
- 1 PC 70-462 Long Nose Plier, single Colour Sleeve, 152mm-6"
- 1 PC STHT84105-8 Diagonal Cutting Plier, 152mm-6"
- 1 PC 84-341-23 Circlip Plier, Bent External, 180mm-7"
- 1 PC STMT93302-8 T-bar Socket 8 Mm
- 1 PC STMT93303-8 T-bar Socket 9 Mm
- 1 PC STMT93304-8 T-bar Socket 10 Mm
- 1 PC STMT93306-8 T-bar Socket 12 Mm
- 1 PC STMT93308-8 T-bar Socket 14 Mm
- 1 PC STMT93309-8 T-bar Socket 17 Mm
- 1 PC 94-346 4.0mm 2-way T-hdl Hex Key
- 1 PC 94-347 5.0mm 2-way T-hdl Hex Key
- 1 PC 94-348 6.0mm 2-way T-hdl Hex Key
- 1 PC 94-350 8.0mm 2-way T-hdl Hex Key
- 1 PC STMT60808-8 C/grip S/driver Ph2x38mm
- 1 PC STMT60812-8 C/grip S/driver Ph2x200mm
- 1 PC STMT60813-8 C/grip S/driver Ph2x250mm
- 1 PC STMT60814-8 C/grip S/driver Ph3x150mm
- 1 PC STMT60819-8 C/grip S/driver 3mmx125mm
- 1 PC STMT60821-8 C/grip S/driver 5mmx75mm
- 1 PC STMT60829-8 C/grip S/driver 6.5mmx200mm
- 1 PC STMT60833-8 C/grip S/driver 8mmx250mm
- 1 PC 89-516-12 3/8" Sq. Dr. 46PC. Dr. (f) \* 1/4" Sq. Dr. (M)
- 1 PC 1-86-214 Adapter 3/8" Sq. Dr. (F) \* 1/4" Sq. Dr. (M)
- 1 PC 1-86-414 1 PC. Adapter 1/2" Sq. Dr. (F) \* 3/8" Sq. Dr. (M)



**HOME TOOL KIT**  
**30PC HOME TOOL SET**



HSN CODE: 84679900

PART No.	DESCRIPTION	MOQ	MRP
STHT74982	30PC HOME TOOL SET	1	2,693

- 1pc 6" (150mm) Adjustable wrench
- 1pc 6" (150mm) Long Nose Pliers
- 1pc 6" (150mm) Universal Plier
- 1pc 6" (150mm) Diagonal Plier
- 1pc Multi bit screwdriver
- 20 bits pieces
- 1pc 8oz hammer
- 1pc Utility knife
- 1pc 9" torpedo level
- 1pc 3m/10' tape measure

**47PC HOME TOOL SET**



HSN CODE: 84679900

PART No.	DESCRIPTION	MOQ	MRP
STHT74981	47PC HOME TOOL SET	1	3,187

- 1pc 16 Hex Keys :1.5,2,2.5,3,4,5,5.5 mm
- 1pc 1/16,5/64,3/32,1/8,5/32,3/16,7/32,1/4 in
- 1pc 9" Torpedo Level
- 1pc 3m/10' Tape Measure
- 1pc 6" (150MM) Adjustable Wrench
- 1pc Precision Screwdriver: 6" (150MM)
- 1pc Long Nose Plier- Ph0 X 40mm, Ph0 X 40mm, 2.5 X 40mm
- 1pc 12 Oz Hammer
- 1pc Magnetic Bit Driver
- 20 bits pieces
- 1pc Utility Knife

**TRADESMEN TOOL KIT**  
**PLUMBER KIT**



HSN CODE: 82059030

PART No.	DESCRIPTION	MOQ	MRP
PLUMBER-KIT	PLUMBER KIT	1	3,550

- 1pc Pipe Wrench(Stillson Pattern) 350mm-14"
- 1pc Water Pump Plier,Crv Steel , 250mm-10"
- 1pc Ball Pein Hammer 220 gms-8 Oz
- 1pc Screwdriver Standard 8mm X 200 mm
- 1pc Cold Chisel 7/8"/22mm
- 1pc Stanley Short Tape Rules 3m/10' x 13mm
- 1pc Mini Hacksaw
- 1pc 16" Tool Box

**ELECTRICIAN KIT**



HSN CODE: 82059030

PART No.	DESCRIPTION	MOQ	MRP
ELECTRICIAN-KIT	ELECTRICIAN KIT	1	3,090

- 1pc 8" combination Plier, double colour sleeve
- 1pc 6" long nose Plier double colour sleeve
- 1pc Wire Stripper, 130mm 5 1/4"
- 1pc Linesman Tester 5mm
- 1pc 35 pc Screwdriver set
- 1pc Slide lock snap off knife 18mm
- 1pc Basic diagonal cutting Pliers 4"
- 1pc Short tape rules 3m/10' x 13mm
- 1pc 12.5" Toolbox metal latch

**CARPENTER KIT**

**NEW**  
 10% OFF  
 10% OFF  
 10% OFF



HSN CODE: 82059030

PART No.	DESCRIPTION	MOQ	MRP
CARPENTER-KIT	CARPENTER KIT	1	3,733

- 1pc Claw Hammer steel shaft 220gms-8"
- 1pc Short Tape rules 5m/16' x 19mm
- 1pc Wood Chisel set, 3 pcs
- 1pc 9" Torpedo Level
- 1pc Retractable utility knife, 156mm
- 1pc 300mm met diecast comb square
- 1pc 12.5" toolbox metal latch

**AC TECHNICIAN KIT**

**NEW**  
 10% OFF  
 10% OFF  
 10% OFF



HSN CODE: 82059030

PART No.	DESCRIPTION	MOQ	MRP
AC-KIT	AC TECHNICIAN KIT	1	6,450

- 1pc Fix bar Screwdriver, phillips ph3 x 200mm
- 1pc Cushion grip Screw driver phillips ph2 x 200mm
- 1pc Cushion grip Screw driver standard 6.5mm x 200 mm
- 1pc Fix bar screwdriver, phillips ph0 x 100mm
- 1pc Fix bar screwdriver, flat 3 x 75mm
- 1pc Hex key ring set 10 pc
- 1pc Linesman tester 3mm
- 1pc Soldering iron
- 1pc 6" long nose plier, single colour sleevee
- 1pc Hacksaw-junior 254mm-10" (150mm-6" blade)
- 1pc T-Handle spanner 17mm
- 1pc Wire Stripper, 130mm 5 1/4"
- 1pc Snap-off knife dynagrip - 25mm
- 1pc Tubing cutter h/d, 3mm-1/8 to 28mm-1 1/4
- 1pc 12.5" toolbox metal latch

**STANLEY®**



**ANTI-SLIP DESIGN**  
 FOR A STRONG GRIP

**400%**

More gripping power

Longer design for better leverage

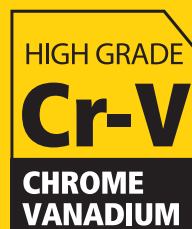



**SPANNERS & SETS**  
**DOUBLE OPEN END SPANNER**  
**DOUBLE OPEN END SPANNER - CRV**



HSN CODE: 82041110

PART No.	SIZE	MOQ	MRP
70-366E	6X7MM	10	33
70-367E	8X9MM	10	34
70-368E	10X11MM	10	39
70-369E	12X13MM	10	43
70-370E	14X15MM	10	45
70-371E	16X17MM	10	59
70-372E	18X19MM	10	73
70-373E	20X22MM	10	87
70-374E	21X23MM	10	117
70-375E	24X27MM	10	145
70-376E	25X28MM	10	172
70-377E	30X32MM	10	187

**DOUBLE OPEN END - JUMBO SPANNER**



HSN CODE: 82041110

PART No.	SIZE	MOQ	MRP
72-060	32X36MM	5	511
72-061	34X36MM	5	511
72-062	36X41MM	5	688
72-063	41X46MM	5	1,341
72-064	46X50MM	2	2213
72-065	50X55MM	2	3,058
72-066	55X60MM	2	3,517

**DOUBLE OPEN END SPANNER SET - CRV**



HSN CODE: 82041110

PART No.	DESCRIPTION	MOQ	CARTON	MRP
70-378	6PC DOE SPANNER SET 6x7, 8x9, 10x11, 12x13, 14x15, 16x17 MM	1	60	247
70-379E	8PC DOE SPANNER SET 6x7, 8x9, 10x11, 12x13, 14x15, 16x17, 18x19, 20x22MM	1	40	399
70-380E	12PC DOE SPANNER SET 6x7, 8x9, 10x11, 12x13, 14x15, 16x17, 18x19, 20x22, 21x23, 24x27, 25x28, 30x32MM	1	15	1,024

**DOUBLE OPEN END SPANNER - ANSI**

AMSE B107.17M



HSN CODE: 82041110

PART No.	SIZE	MOQ	MRP
STMT23104	6X7MM	10	88
STMT23106	6X8MM	10	88
STMT23107	7X9MM	10	117
STMT23108	8X10 MM	10	117
STMT23109	10X11MM	10	121
STMT23111	10X12MM	10	121
STMT23112	11X13MM	10	138
STMT23113	12X14MM	10	138
STMT23114	13X15MM	10	187
STMT23115	14X17MM	6	226
STMT23116	16X18MM	6	242
STMT23117	17X19MM	6	267
STMT23119	19X21MM	4	353
STMT23120	21X23MM	4	412
STMT23121	22X24MM	4	491
STMT23128	24X26MM	4	520
STMT23122	24X27MM	4	520
STMT23123	30X32MM	4	648

**DOUBLE OPEN END SPANNER SET - ANSI**

AMSE B107.17M



HSN CODE: 82041110

PART No.	DESCRIPTION	MOQ	MRP
STMT23124	9PC DOE SPANNER SET 6x7, 7x9, 8x10, 10x12, 11x13, 12x14, 17x19, 19x21, 22x24MM	1	1,878

**COMBINATION SPANNER**  
**COMBINATION SPANNER - CRV**



HSN CODE: 82041110

PART No.	SIZE	MOQ	MRP
70-936E	6MM	10	41
70-937E	7MM	10	41
70-938E	8MM	10	41
70-939E	9MM	10	41
70-940E	10MM	10	45
70-941E	11MM	10	45
70-942E	12MM	10	46
70-943E	13MM	10	51
70-944E	14MM	10	62
70-945E	15MM	10	65
70-946E	16MM	10	74
70-947E	17MM	10	75
70-948E	18MM	10	91
70-949E	19MM	10	96
70-950E	20MM	10	120
70-951E	21MM	10	126
70-952E	22MM	10	146
70-953E	23MM	5	162
70-954E	24MM	5	179
70-955E	25MM	5	199
70-956E	26MM	5	217
70-957E	27MM	5	259
70-961E	32MM	5	399

### COMBINATION SPANNER SET - CRV

**NEW**  
High Grade  
Cr-V Chrome Vanadium  
with Anti Slip



HSN CODE: 82041110

PART No.	DESCRIPTION	MOQ	CARTON	MRP
70-962	6PC ( 8,10,12,13,14 &17 MM)	1	40	314
70-963E	8PC COMB SPANNER SET 8-11, 13, 14,17&19MM	1	20	455
70-964E	12PC COMB SPANNER SET 6-14, 17, 19&22MM	1	10	723
70-965E	23PC COMB SPANNER SET 6-25, 27, 30&32MM	1	4	2,940

### RATCHETING SPANNER



HSN CODE: 82041120

PART No.	OLD PART No.	SIZE	MOQ	MRP
STMT89934-8B	STMT89934-8B-12	8 MM	10	620
STMT89935-8B	STMT89935-8B-12	9 MM	10	624
STMT89936-8B	STMT89936-8B-12	10 MM	10	625
STMT80012-8B	STMT80012-8B-12	11 MM	10	647
STMT89937-8B	STMT89937-8B-12	12 MM	10	647
STMT89938-8B	STMT89938-8B-12	13 MM	10	694
STMT89939-8B	STMT89939-8B-12	14 MM	10	724
STMT89940-8B	STMT89940-8B-12	15 MM	10	763
STMT89941-8B	STMT89941-8B-12	16 MM	10	838
STMT89942-8B	STMT89942-8B-12	17 MM	10	857
STMT89943-8B	STMT89943-8B-12	18 MM	10	910
STMT89944-8B	STMT89944-8B-12	19 MM	10	930

### COMBINATION SPANNER (INCHES) - ANSI

AMSE B107.17M



HSN CODE: 82041120

PART No.	SIZE	MOQ	MRP
STMT80246-8B	1/4"	10	63
STMT80247-8B	5/16"	10	65
STMT80248-8B	3/8"	10	73
STMT80250-8B	7/16"	10	75
STMT80251-8B	1/2"	10	87
STMT80252-8B	9/16"	10	91
STMT80253-8B	5/8"	10	127
STMT80254-8B	11/16"	6	141
STMT80255-8B	3/4"	6	164
STMT80256-8B	13/16"	6	175
STMT80257-8B	7/8"	6	198
STMT80258-8B	15/16"	6	271
STMT80265-8B	1"	6	339

### COMBINATION SPANNER SET - ANSI

AMSE B107.17M



HSN CODE: 82041120

PART No.	DESCRIPTION	MOQ	CARTON	MRP
STMT78092-8	14PC COMB SPANNER SET (METRIC) 8, 9, 10, 11, 12, 13, 14, 15, 16, 17, 19, 21, 22&24MM	1	4	2,107
STMT78096-8	13PC COMB SPANNER SET (INCHES) 1/4", 5/16", 3/8", 7/16", 1/2", 9/16", 5/8", 11/16", 3/4", 13/16", 7/8", 15/16", 1"	1	6	2,195

### SLIMLINE COMBINATION SPANNER SET - CRV

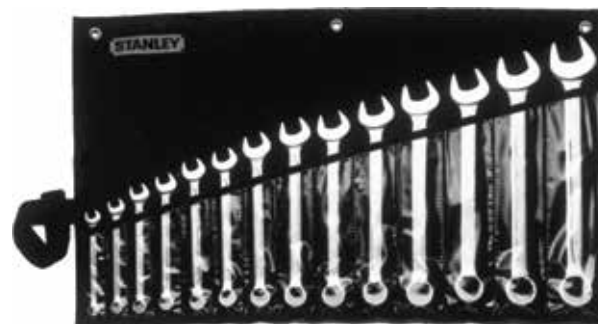

HSN CODE: 82041110

PART No.	DESCRIPTION	MOQ	MRP
1-87-709	14 PC SLIMLINE COMB SPANNER SET (INCHES) 3/8", 7/16", 1/2", 9/16", 5/8", 11/16", 3/4", 13/16", 7/8", 15/16", 1", 11/16", 11/8", 11/4"	1	6,946
1-87-038	14 PC SLIMLINE COMB SPANNER SET (METRIC) 10, 11, 12, 13, 14, 17, 19, 21, 22, 23, 24, 26, 30, 32MM	1	6,466

### RING SPANNER

### SHALLOW OFFSET BI-HEX RING SPANNER - CRV



HSN CODE: 82041110

PART No.	SIZE	MOQ	MRP
70-381E	6X7MM	10	66
70-382E	8X9MM	10	76
70-383E	10X11MM	10	92
70-384E	12X13MM	10	96
70-385E	14X15MM	10	106
70-386E	16X17MM	10	127
70-387E	18X19MM	10	160
70-388E	20X22MM	10	189
70-389E	21X23MM	5	228
70-390E	24X27MM	5	276
70-391E	25X28MM	5	328
70-392E	30X32MM	5	420

**DEEP OFFSET BI-HEX RING SPANNER - CRV**



HSN CODE: 82041110

PART No.	SIZE	MOQ	MRP
72-067	32X36MM	5	894
72-068	36X41MM	5	1,249
72-069	41X46MM	5	3,663
72-070	46X50MM	2	4,119
72-071	50X55MM	2	6,592
72-072	55X60MM	2	7,533

**SHALLOW OFFSET RING SPANNER SET - CRV**



HSN CODE: 82041110

PART No.	DESCRIPTION	MOQ	CARTON	MRP
70-393	6PC SHAL OFFSET BI-HX RNG SPANNER SET 6X7, 8X9, 10X11, 12X13, 14X15, 16X17 MM	1	30	557
70-394E	8PC SHAL OFFSET BI-HX RNG SPANNER SET 6X7, 8X9, 10X11, 12X13, 14X15, 16X17, 18X19, 20X22MM	1	20	928
70-395E	12PC 6X7, 8X9, 10X11, 12X13, 14X15, 16X17, 18X19, 20X22, 21X23, 24X27, 25X28, 30X32MM	1	6	2,190

**SHALLOW OFFSET RING SPANNER - ANSI**

AMSE B107.17M



HSN CODE: 82041110

PART No.	DESCRIPTION	MOQ	MRP
STMT25133	6X7MM	10	163
STMT25134	8X9MM	10	184
STMT25135	8X10MM	10	184
STMT25136	10X12MM	10	200
STMT25137	11X13MM	10	221
STMT25138	12X14MM	10	221
STMT25139	14X17MM	10	271
STMT25140	16X18MM	6	282
STMT25141	17X19MM	6	316
STMT25142	19X21MM	6	366
STMT25143	21X23MM	6	404
STMT25144	22X24MM	6	404
STMT25169	24X26MM	4	578
STMT25145	24X27MM	4	578
STMT25146	30X32MM	4	703

**SHALLOW OFFSET RING SPANNER SET - ANSI**

AMSE B107.17M



HSN CODE: 82041110

PART No.	DESCRIPTION	MOQ	MRP
STMT25147	9 PC OFFSET RING SPANNER SET 6x7, 8x9, 8x10, 10x12, 11x13, 12x14, 17x19, 19x21, 22x24MM	1	2,389

**T-HANDLE SPANNER**  
**T-HANDLE SPANNER - ANSI**



HSN CODE: 82042000

PART No.	SIZE	MOQ	MRP
STMT93302-8	8MM	10	520
STMT93303-8	9MM	10	520
STMT93304-8	10MM	10	520
STMT93305-8	11MM	10	507
STMT93306-8	12MM	10	535
STMT93307-8	13MM	10	535
STMT93308-8	14MM	10	541
STMT93309-8	17MM	10	660

**CROSS WRENCH**



HSN CODE: 82041120

PART No.	SIZE	MOQ	MRP
STMT94030-8	CROSS WRENCH - (17, 19, 21, 23MM)	2	1,325

**ADJUSTABLE SPANNER**  
**ADJUSTABLE WRENCH PHOSPHATE PLATED**



HSN CODE: 82041220

PART No.	DESCRIPTION	MOQ	MRP
STMT74893-8	ADJUSTABLE WRENCH 150MM-6"	5	247
STMT74894-8	ADJUSTABLE WRENCH 200MM-8"	5	323
STMT74895-8	ADJUSTABLE WRENCH 250MM-10"	5	441
STMT74896-8	ADJUSTABLE WRENCH 300MM-12"	5	554

**ADJUSTABLE WRENCH CHROME PLATED**



HSN CODE: 82041220

PART No.	DESCRIPTION	MOQ	MRP
1-87-430	ADJUSTABLE WRENCH 100MM-4"	6	353
STMT87431-8	ADJUSTABLE WRENCH 150MM-6"	6	417
STMT87432-8	ADJUSTABLE WRENCH 200MM-8"	6	543
STMT87433-8	ADJUSTABLE WRENCH 250MM-10"	6	671
STMT87434-8	ADJUSTABLE WRENCH 300MM-12"	6	846
STMT87435-8	ADJUSTABLE WRENCH 375MM-15"	4	1,648

### HD ADJUSTABLE WRENCH



HSN CODE: 82041220

PART No.	DESCRIPTION	MOQ	MRP
87-796-23	HD ADJUSTABLE WRENCH 18"	1	3,091

### PIPE WRENCH - STILLSON PATTERN



HSN CODE: 82041120

PART No.	DESCRIPTION	MOQ	MRP
71-641	PIPE WRENCH 250MM-10"	6	357
71-642	PIPE WRENCH 300MM-12"	6	472
71-643	PIPE WRENCH 350MM-14"	4	577
71-644	PIPE WRENCH 450MM-18"	4	939
71-645	PIPE WRENCH 600MM-24"	2	1,719

### PIPE WRENCH - HEAVY DUTY



HSN CODE: 82041120

PART No.	DESCRIPTION	MOQ	MRP
87-622-23	PIPE WRENCH 250MM-10"	6	626
87-623-23	PIPE WRENCH 300MM-12"	6	833
87-624-23	PIPE WRENCH 350MM-14"	6	1,176
87-625-23	PIPE WRENCH 450MM-18"	2	1,957
87-626-23	PIPE WRENCH 600MM-24"	1	2,675
87-627-23	PIPE WRENCH 900MM-36"	1	5,234

### SLOGGING SPANNER OPEN END SLOGGING SPANNER



HSN CODE: 82041120

PART No.	SIZE	MOQ	MRP
96-936-23	30MM	1	1,270
96-938-23	32MM	1	1,500
96-939-23	36MM	1	1,792
96-940-23	41MM	1	2,276
96-941-23	46MM	1	2,835
96-950-23	50MM	1	3,507
96-951	55MM	1	3,880
96-952	60MM	1	4,217
96-953	65MM	1	4,613
96-954-23	70MM	1	5,671

### RING SLOGGING SPANNER



HSN CODE: 82041120

PART No.	SIZE	MOQ	MRP
71-682	24MM	1	940
96-911	27MM	1	1,093
96-913	30MM	1	1,200
96-914	32MM	1	1,315
96-915	36MM	1	1,514
96-917	41MM	1	1,917
96-918	46MM	1	2,461
96-919	50MM	1	2,839
96-920	55MM	1	3,355
96-921	60MM	1	3,329
96-922	65MM	1	4,048
96-923	70MM	1	7,462
96-924	75MM	1	7,648



**PLIERS**

**COMBINATION PLIER**

70-461



70-482



HSN CODE: 82032000

PART No.	DESCRIPTION	MOQ	CARTON	MRP
70-461	8" COMBINATION PLIER,	6	60	308
70-482	8" COMBINATION PLIER, BI-MATERIAL	6	60	312

**MULTI - TOOL PLIER  
MULTI-TOOL - 12 IN 1**



HSN CODE: 82055990

PART No.	DESCRIPTION	MOQ	MRP
1-84-519	MULTITOO - 12 IN 1 WITH A POUCH	12	1,282

**LONG NOSE PLIER**

70-462



STHT84102



HSN CODE: 82032000

PART No.	DESCRIPTION	MOQ	MRP
70-462	6" LONG NOSE PLIER	6	252
70-483	6" LONG NOSE PLIER, BI-MATERIAL	6	273
STHT84402	6" LONG NOSE PLIER (BULK PACK)	18	260
STHT84102-8	8" LONG NOSE PLIER LENGTH NOSE PLIER	6	468

**LINESMAN PLIER**



HSN CODE: 82032000

PART No.	DESCRIPTION	MOQ	MRP
STHT84113-8	LINESMAN PLIER 8" LENGTH	6	562
STHT84112-8	LINESMAN PLIER 7" LENGTH	6	501

**CUTTING PLIER**



HSN CODE: 82032000

PART No.	DESCRIPTION	MOQ	MRP
STHT84105-8	CUTTING PLIER 6" LENGTH	6	385
STHT84108-8	CUTTING PLIER 7" LENGTH	6	435

**PLASTIC NIPPER**



HSN CODE: 82032000

PART No.	DESCRIPTION	MOQ	MRP
84-134-1-23	PLASTIC NIPPER 127MM-5"	6	754
84-135-1-23	PLASTIC NIPPER 152MM-6"	6	858

**SLIP JOINT PLIER**



HSN CODE: 82032000

PART No.	DESCRIPTION	MOQ	MRP
STHT84401	STANLEY 6IN SLIP JOINT PLIER	18	232

**TOWER PINCER**



HSN CODE: 73269099

PART No.	DESCRIPTION	MOQ	MRP
84-282	TOWER PINCERS 10 250MM	6	444

**PLIER SET**

**3PC PLIERS SET**



HSN CODE: 82032000

PART No.	DESCRIPTION	MOQ	MRP
STHT84405	1PC 6INCH SLIP JOINT PLIER, 1PC 6 INCH LONG NOSE PLIER AND 1PC 6INCH CUTTING PLIER	5	929

**MINIATURE PLIER**

**MINIATURE BASIC PLIERS**



HSN CODE: 82032000

PART No.	DESCRIPTION	MOQ	MRP
84-096-23	PLIERS MINI NEEDLE NOSE 5"	6	232
STHT84119-8	MINIATURE BASIC LONG NOSE PLIERS 5"	6	232
STHT84122-8	MINIATURE BASIC FLAT NOSE PLIERS 4"	6	232
STHT84124-8	MINIATURE BASIC DIAGONAL CUTTING PLIERS 4"	6	232
STHT84125-8	MINIATURE BASIC END NIPPER PLIERS 4"	6	232
STHT84126-8	MINIATURE BASIC BENT NOSE PLIERS 5"	6	232

### WIRE CUTTER



HSN CODE: 82032000

PART No.	DESCRIPTION	MOQ	MRP
84-214-22	WIRE CUTTER, 130MM 5 1/4"	15	360

### WIRE STRIPPER WIRE STRIPPER



HSN CODE: 82032000

PART No.	DESCRIPTION	MOQ	MRP
84-475-22	WIRE STRIPPER(CUTTER)-AWG12-22, 150MM-6	10	890

### AUTOMATIC WIRE STRIPPER



HSN CODE: 82032000

PART No.	DESCRIPTION	MOQ	MRP
FMHT0-96230	AUTOMATIC WIRE STRIPPER	1	1,642

### WATER PUMP PLIER WATER PUMP PLIER



HSN CODE: 82032000

PART No.	DESCRIPTION	MOQ	MRP
71-668	WATER PUMP PLIER, 175MM-7"	10	339
71-669	WATER PUMP PLIER, 250MM-10"	10	409
71-670	WATER PUMP PLIER, 300MM-12"	4	694



### PLIER GROOVE JOINT



HSN CODE: 82032000

PART No.	DESCRIPTION	MOQ	MRP
84-110-23	PLIER GROOVE JOINT-10"	6	583
84-111	PLIER GROOVE JOINT-12"	4	799

### CIRCLIP PLIER PLIER CIRCLIP, BENT EXTERNAL



HSN CODE: 82032000

PART No.	DESCRIPTION	MOQ	MRP
84-338-23	PLIER CIRCLIP, BENT EXTERNAL 130MM-5"	6	402
84-341-23	PLIER CIRCLIP, BENT EXTERNAL 180MM-7"	6	530
84-348-23	PLIER CIRCLIP, BENT EXTERNAL 230MM-9"	6	624

### PLIER CIRCLIP, BENT INTERNAL



HSN CODE: 82032000

PART No.	DESCRIPTION	MOQ	MRP
84-446-23	PLIER CIRCLIP, BENT INTERNAL 130MM-5"	6	402
84-447-23	PLIER CIRCLIP, BENT INTERNAL 180MM-7"	6	530
84-448-23	PLIER CIRCLIP, BENT INTERNAL 230MM-9"	6	624

### PLIER CIRCLIP, STRAIGHT INTERNAL



HSN CODE: 82032000

PART No.	DESCRIPTION	MOQ	MRP
84-362-23	PLIER CIRCLIP, STRAIGHT INTERNAL 130MM-5"	6	402
84-363-23	PLIER CIRCLIP, STRAIGHT INTERNAL 180MM-7"	6	530
84-364-23	PLIER CIRCLIP, STRAIGHT INTERNAL 230MM-9"	6	624

### PLIER CIRCLIP, STRAIGHT EXTERNAL



HSN CODE: 82032000

PART No.	DESCRIPTION	MOQ	MRP
84-332-23	PLIER CIRCLIP, STRAIGHT EXTERNAL 130MM-5"	6	402
84-334-23	PLIER CIRCLIP, STRAIGHT EXTERNAL 180MM-7"	6	530
84-335-23	PLIER CIRCLIP, STRAIGHT EXTERNAL 230MM-9"	6	624



**COMBINATION SNAP RING INT-EXT POST**



HSN CODE: 82032000

PART No.	DESCRIPTION	MOQ	MRP
84-168	COMBINATION SNAP RING INT-EXT POST, 152MM-6"	1	833

**LOCKING PLIER  
LOCKING PLIER - CURVED JAW**



HSN CODE: 82059090

PART No.	DESCRIPTION	MOQ	MRP
84-367-1-5	CURVED JAW LOCKING PLIER-5 IN LENGTH	6	380
84-368	CURVED JAW LOCKING PLIER-7 IN LENGTH	6	528
84-369-1-23	BI-MAT HANDLE, CURVED LOCK PLIER, 254MM-10"	6	1,035

**LOCKING PLIER - STRAIGHT JAW**



HSN CODE: 82059090

PART No.	DESCRIPTION	MOQ	MRP
84-371	STRAIGHT JAW LOCKING PLIER-10 IN LENGTH	6	643

**LOCKING PLIER - LONG NOSE**



HSN CODE: 82032000

PART No.	DESCRIPTION	MOQ	MRP
84-389	LONG NOSE LOCKING PLIER-9.5 IN LENGTH	6	602



**SCREWDRIVERS**  
**SCREWDRIVER SETS**

**16PC CUSHION GRIP SCREWDRIVER SET**



HSN CODE: 82054000

PART No.	DESCRIPTION	MOQ	MRP
68-0002C	16PC CUSHION GRIP SCREWDRIVER SET	1	2,551

**17PC SCREWDRIVER SET**



HSN CODE: 82054000

PART No.	DESCRIPTION	MOQ	MRP
STMT65616-LA	17PC SCREWDRIVER SET	4	1,429

**6PC CUSHION GRIP SCREWDRIVER SET**



HSN CODE: 82054000

PART No.	DESCRIPTION	MOQ	MRP
STHT65242-8	6PC CUSHION GRIP SET -CARDED	1	1,190
STHT92002-8	6PC SET W/BONUS(TESTER INCLUDED)	1	1,247

**9 WAY SCREWDRIVER SET**



- ⊕ OPT 1 PT, 2PT
- ⊖ OPT 1/8" 3mm, 3/16" 5mm, 1/4" 6mm



HSN CODE: 82054000

PART No.	DESCRIPTION	MOQ	CARTON	MRP
STHT62511-8	9-WAY SCREWDRIVER	6	24	956

**35 IN 1 SCREWDRIVER SET**



HSN CODE: 84615019

PART No.	DESCRIPTION	MOQ	MRP
STHT0-70885	35 IN 1 SCREWDRIVER SET.	6	699

**10PC RATCHETING MULTI-BIT SCREWDRIVER**



HSN CODE: 82054000

OLD PART No.	DESCRIPTION	MOQ	CARTON	MRP
STHT68010-8	10PC RATCHETING MULTI-BIT SCREWDRIVER	6	36	572

**29PC SCREWDRIVER INSERT BIT SET**



HSN CODE: 82054000

PART No.	DESCRIPTION	MOQ	MRP
68-071-23	SCREWDRIVER INSERT BIT 29PC SET	6	412

**6PC SCREWDRIVER PRECISION SET**



HSN CODE: 82054000

PART No.	DESCRIPTION	MOQ	MRP
66-039	S/DVR PRECISION SET 6PC	12	398
66-052	SCREWDRIVER SET PRECISION BI-MATERIAL	6	371

**6 WAY SCREWDRIVER SET**

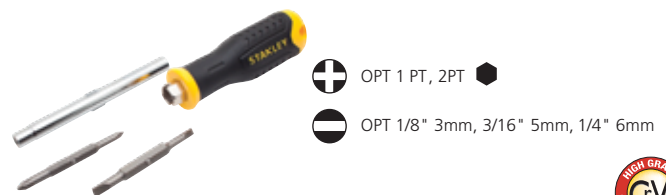

- ⊕ OPT 1 PT, 2PT
- ⊖ OPT 1/8" 3mm, 3/16" 5mm, 1/4" 6mm



HSN CODE: 82054000

OLD PART No.	PART No.	DESCRIPTION	MOQ	MRP
STHT68012-812	STHT68012-8	6-WAY SCREWDRIVER	6	285

**4 WAY PEN SCREWDRIVER**



HSN CODE: 82054000

PART No.	DESCRIPTION	MOQ	MRP
66-344	4 WAY PEN SCREWDRIVER	8	179



### C/GRIP SCREWDRIVERS & SETS CUSHION GRIP SCREWDRIVER STANDARD



HSN CODE: 82054000

PART No.	SIZE	MOQ	MRP
STMT60817-8	3x75mm	12	142
STMT60818-8	3x100mm	12	142
STMT60819-8	3x125 mm	12	143
STMT60820-8	3mm X 150 mm	12	178
STMT60821-8	5mm X 75 mm	12	178
STMT60822-8	5mm X 100 mm	12	182
STMT60823-8	5mm X 150 mm	12	193
STMT60824-8	5mm X 200 mm	12	204
STMT60825-8	6.5mm X 38 mm(STUBBY)	12	198
STMT60826-8	6.5mm X 100 mm	12	199
STMT60827-8	6.5mm X 125 mm	12	206
STMT60828-8	6.5mm X 150 mm	12	213
STMT60829-8	6.5mm X 200 mm	12	225
STMT60830-8	6.5mm X 250 mm	12	241
STMT60831-8	8mm X 150 mm	12	263
STMT60832-8	8mm X 200 mm	12	277
STMT60833-8	8mm X 250 mm	12	292
STMT60834-8	5x100mm (Parallel)	12	182
STMT60835-8	5x150mm (Parallel)	12	188
STMT60836-8	5x200mm (Parallel)	12	205

### CUSHION GRIP SCREWDRIVER PHILLIPS



HSN CODE: 82054000

PART No.	SIZE	MOQ	MRP
STMT60800-8	PH0 x 75 mm	12	121
STMT60801-8	PH0 x 100 mm	12	139
STMT60802-8	PH0 x 125mm	12	146
STMT60803-8	PH0 x 150mm	12	146
STMT60804-8	PH1x75mm	12	153
STMT60805-8	PH1 x 100mm	12	178
STMT60806-8	PH1 x 150mm	12	159
STMT60807-8	PH1 x 200mm	12	195
STMT60808-8	PH2 x 38mm (STUBBY)	12	171
STMT60809-8	PH2 x 100mm	12	192
STMT60810-8	PH2 x 125mm	12	199
STMT60811-8	PH2 x 150mm	12	203
STMT60812-8	PH2 x 200mm	12	213
STMT60813-8	PH2 x 250mm	12	234
STMT60814-8	PH3 x 150mm	12	248
STMT60816-8	PH3 x 250mm	12	281

### CUSHION GRIP SCREWDRIVER TORX



HSN CODE: 82054000

PART No.	SIZE	MOQ	MRP
STMT60837-8	T5x75mm	12	133
STMT60838-8	T6x75mm	12	133
STMT60839-8	T7x75mm	12	136
STMT60841-8	T8x75mm	12	139
STMT60844-8	T10x75mm	12	139
STMT60845-8	T15x100mm	12	164
STMT60847-8	T20x100mm	12	186
STMT60848-8	T25x100mm	12	210
STMT60850-8	T30x100mm	12	210

### FIX BAR SCREWDRIVER STANDARD



HSN CODE: 82054000

PART No.	SIZE	MOQ	MRP
62-241	3 X 50MM	10	42
62-242	3 X 75MM	10	52
62-243	3 X 100MM	10	55
62-244	3 X 150MM	10	52
62-245	4 X 75MM	10	61
62-246	4 X 150MM	10	67
62-247	6 X 100MM	10	91
62-248	6 X 150MM	10	93
62-249	6 X 200MM	10	101
62-250	6 X 250MM	10	109
62-251	6 X 300MM	10	121
62-252	8 X 150MM	10	136
62-253	8 X 200MM	10	152
62-254	8 X 250MM	10	165
62-255	8 X 300MM	10	174

### FIX BAR SCREWDRIVERS FIX BAR SCREWDRIVER PHILLIPS



HSN CODE: 82054000

PART No.	SIZE	MOQ	MRP
62-256	PH0 X 50MM	10	45
62-257	PH0 X 100MM	10	46
62-258	PH0 X 150MM	10	62
62-259	PH1 X 100MM	10	70
62-260	PH1 X 150MM	10	79
62-261	PH1 X 200MM	10	92
62-262	PH2 X 100MM	10	109
62-263	PH2 X 150MM	10	112
62-264	PH2 X 200MM	10	116
62-265	PH2 X 250MM	10	120
62-266	PH2 X 300MM	10	128
62-267	PH3 X 150MM	10	150
62-268	PH3 X 200MM	10	147
62-269	PH3 X 250MM	10	169
62-270	PH3 X 300MM	10	178

### 2in1 SCREWDRIVER



HSN CODE: 82054000

PART No.	DESCRIPTION	MOQ	MRP
66-432	PHILLIPS #2 X FLAT 6.0MM X 28MM (STUBBY)	12	102
66-433	PHILLIPS 2in1 SCREWDRIVER PH0 X FLAT 3.5MM X 55MM	12	87
66-434	PH1 X FLAT 5.0MM X 75MM	12	102
66-435	PH00 X FLAT 2.3MM X 60MM	12	90
66-436	PH1 X PH0 X 200MM	12	110
66-437	PH2 X PH1 X 200MM	12	146
66-438	PH3 X PH2 X 200MM	12	196
66-439	PH2 X FLAT 6.0MM X 250MM, INSULATED	12	158
66-446	PH2 X FLAT 6.0MM X 100MM, INSULATED	12	133
66-447	PH2 X FLAT 6.0MM X 140MM, INSULATED	12	133
66-448	PH3 X FLAT 8.0MM X 140MM	12	171
66-449	PH2 X FLAT 6.0MM X 200MM	12	137

### TESTERS

#### DIGITAL DETECTION SCREWDRIVER



HSN CODE: 82054000

PART No.	DESCRIPTION	MOQ	MRP
66-137	DIGITAL DETECTION SCREWDRIVER	12	169

### LINESMAN TESTER



100-500V



HSN CODE: 82054000

PART No.	DESCRIPTION	MOQ	CARTON	MRP
66-119	3MM	20	100	60
66-120	5MM	20	100	85

### HEX KEYS

#### HEX KEY SETS

69-256



STMT69213-8



HSN CODE: 82041120

PART No.	DESCRIPTION	MOQ	MRP
STMT69213-8	HEX KEY RING SET 10 PC (1.5, 2, 2.5, 3, 4, 5, 5.5, 6, 8, 10mm)	12	302
69-230	HEX KEY SET-RING, 10PC, IMPERIAL (1/16, 5/64, 3/32, 1/8, 5/32, 3/16, 7/32, 1/4, 5/16, 3/8)	12	294
69-253	HEX KEY SET 10PC METRIC (1.5, 2, 2.5, 3, 4, 5, 5.5, 6, 8, 10mm)	12	369
69-256	HEX KEY SET, 9PC, METRIC, L/ARM BALL (1.5, 2, 2.5, 3, 4, 5, 6, 8, 10mm Ball Tips)	6	916
69-257	HEX KEY SET, 12PC, IMPERIAL, L/ARM (1/16, 5/64, 3/32, 7/64, 1/8, 9/64, 5/32, 3/16, 7/32, 1/4, 5/16, 3/8 Ball Tips)	6	1,031

#### 12PC LONG BALL POINT HEX KEY



HSN CODE: 82041120

PART No.	DESCRIPTION	MOQ	MRP
94-163-23	12PC. LONG BALL POINT HEX KEY (1/16, 5/64, 3/32, 7/64, 1/8, 9/64, 5/32, 3/16, 7/32, 1/4, 5/16, 3/8)	6	1,533

#### 9PC EXTRA LONG BALL POINT HEX KEY



HSN CODE: 82041120

PART No.	DESCRIPTION	MOQ	MRP
94-158	9PC EXTRA LONG BALL POINT HEX (1.5, 2, 2.5, 3, 4, 5, 6, 8, 10)	6	1,507

#### 9PC LONG SPHERICAL HEAD HEX KEY



HSN CODE: 82041120

PART No.	DESCRIPTION	MOQ	MRP
STMT94162-8	9 PC LONG SPHERIC-HEAD HEX KEY SET (1.5, 2, 2.5, 3, 4, 5, 6, 8, 10 mm)	6	1,275

#### 8PC LONG L-TYPE TAMPER PROOF TORX HEX KEY



HSN CODE: 82041120

PART No.	DESCRIPTION	MOQ	MRP
92-624	8PC LONG L-TYPE TAMPERPROOF TORX, HEXKEY (T6, T7, T8, T9, T10, T15, T20, T25)	12	1,254

#### 9PC LONG TORX KEY SET



HSN CODE: 82041120

PART No.	DESCRIPTION	MOQ	MRP
STMT92625-8	9PC LONG TORX KEY SET (T10, T15, T20, T25, T27, T30, T40, T45, T50)	6	1,799

### HEX KEYS

#### LONG BALL END HEX KEY



HSN CODE: 82041120

PART No.	SIZE	MOQ	MRP
STMT94099-8	1.5MM	6	69
94-080	2MM	6	97
STMT94101-8	2.5MM	6	106
STMT94102-8	3MM	6	97
STMT94103-8	4MM	6	122
STMT94104-8	5MM	6	146
STMT94106-8	6MM	6	188
STMT94108-8	8MM	6	241
94-088	10MM	3	369

#### LONG HEX KEY



HSN CODE: 82041120

PART No.	SIZE	MOQ	MRP
94-149	12MM	3	334
94-150	14MM	12	493
94-151	16MM	12	657

#### 2-WAY T-HANDLE HEX KEY



HSN CODE: 82041120

PART No.	SIZE	MOQ	MRP
94-346	4.0MM	12	349
94-347	5.0MM	12	384
94-348	6.0MM	12	520
94-350	8.0MM	12	554

**FASTENING TOOLS**

**GLUE GUNS**

**GLUE GUN**



- Quality engineered for reliable performance
- Trigger-feed mechanism controls glue flow
- Heats up quickly and bonds within 60 seconds
- Use 1-GS15DT/1-GS20DT
- Fold-out stand for safe, handy storage while in use

HSN CODE: 85151100

PART No.	DESCRIPTION	MOQ	MRP
69-GR20B	GLUE-REG GUN ROUND PIN 100-240V CE	6	1,009

**CORDLESS GLUE GUN**



- Trigger-feed mechanism controls glue flow, heats up quickly and bonds within 60 seconds
- Use 1-GS15DT/1-GS20DT

HSN CODE: 84672900

PART No.	DESCRIPTION	MOQ	MRP
STHT6-70416	25-WATTS PLASTIC CORDLESS GLUE GUN	1	1,938

**GLUE STICKS**

**GLUE STICKS**



HSN CODE: 35069999

PART No.	DESCRIPTION	MOQ	MRP
1-GS15DT	DUAL MELT 6PK 11.3MM GLUE STICK FOR 69GR20B AND STHT6-70416	12	97
1-GS20DT	DUAL MELT 24PK 11.3MM GLUE STICK FOR 69GR20B AND STHT6-70416	6	309



**RIVETERS**

**STANLEY RIVETER**

STHT69646-8

STHT69800-8



HSN CODE: 82032000

PART No.	DESCRIPTION	MOQ	MRP
STHT69646-8	MEDIUM DUTY RIVETER 3 NOZZLES	6	714
STHT69800-8	RIVETER-HEAVY DUTY, C/W 4 NOZZLES	6	752



**SOLDERING IRON**

**SOLDERING IRON**



HSN CODE: 85151100

PART No.	DESCRIPTION	MOQ	MRP
69-031B	SOLDERING IRON 30W/220V ROUND PIN	20	657

**STAPLES**

**LIGHT DUTY STAPLE GUN**



- All plastic light-duty staple gun
- Large window on stapler for indicating when staples need to be reloaded
- Used for screen repairs, light upholstery, craft projects, office, home, and school tacking

HSN CODE: 84729010

PART No.	DESCRIPTION	MOQ	MRP
6-TR35	LIGHT DUTY STAPLE GUN	6	788

**LIGHT DUTY STAPLE PIN**



- Only suitable for light duty staplers

HSN CODE: 83052000

PART No.	DESCRIPTION	MOQ	MRP
1-TRA204T	6MM/1/4" L/D STAPLES A TYPE	7	129
1-TRA205T	8MM/5/16" L/D STAPLES A TYPE	6	147
1-TRA206T	10MM/3/8" L/D STAPLES A TYPE	5	152

### SOCKETS & RATCHETS

#### 1/4" DRIVE SOCKET SET

#### 46PC 1/4 SQ. DR. SOCKET & BIT SET



1/4 Drive

HSN CODE: 82042000

PART No.	DESCRIPTION	MOQ	CARTON	MRP
STMT72794-8	46PC 1/4 SQ.DR. SOCKET & BIT SET	1	40	3,096

- 1 PC 1/4 Drive Quick Release Ratchet
- 2 PC 1/4 Drive Extensions: 50 and 100mm
- 1 PC 1/4 Drive Flexible Extension
- 1 PC 1/4 Drive Universal Joint
- 1 PC 1/4 Drive Sliding T-bar
- 1 PC Drive Spinner Handle
- 4 PC 1/4 Hex Keys 1.5,2,2.5,3mm
- 22 PC 1/4 Drive Bit Sockets- Hex 3,4,5,6,7,8mm
- Torx® T8,T10,T15,T20,T25,T30,T40 Phillips® 1 Pt, 2 Pt, 3 pt
- Pozidrive® 1,2,3 Slotted- 4,5,5,7mm
- 13 PC 1/4 Drive 6 Point Sockets: 4,4.5,5,5.5,6,7,8,9,10,11,12,13,14mm

#### 37 PC 1/4" COMPACT SOCKET SET



1/4 Drive

HSN CODE: 82042000

PART No.	DESCRIPTION	MOQ	CARTON	MRP
STMT82672-0	37 PC 1/4" COMPACT SOCKET SET	1	10	1,922

- 1 PC 1/4" 72 Tooth Bi-material Ratchet
- 12 PC 1/4" Sockets (12-points): 4, 4.5, 5, 6, 7, 8, 9, 10, 11, 12, 13, 14MM
- 1 PC 1/4" Short Extension: 3"
- 1 PC Bit Holder
- 22 PC 1/4"
- Bits: PZ1, PZ2, PZ3, PH1, PH2, PH3
- Hex: 3, 4, 5, 6, 7
- Torx: 10, 15, 20, 25, 27, 30, 40
- Slotted: 4, 5, 6, 7

#### 35PC 1/4 SQ. DR. SOCKET SET 6PT MET



1/4 Drive

HSN CODE: 82042000

PART No.	DESCRIPTION	MOQ	MRP
1-89-033	35PC 1/4 SQ. DR. SOCKET SET 6PT MET	1	2,272

- 13 PC 1/4 Drive 6 Point Sockets: 4,4.5,5,5.5,6,7,8,9,10,11,12,13,14mm
- 1 PC Spinner Handle
- 2 PC Extensions : 75,150mm
- 1 PC Universal Joint
- 1 PC " Professional" Ratchet
- 1 PC Hex Bit Holder
- 4 PC Hex Bit:3,4,5,6mm
- 6 PC Torx® Bits: T-10,T-15,T-20,T-25,T-30,T-40
- 3 PC Posidrive® Bits: 1,2,3
- 3 PC Slotted Bits: 4,5,5,6.5

#### 1/4" DRIVE RATCHET

#### 1/4" PEAR HEAD RATCHET



1/4 Drive

HSN CODE: 82042000

PART No.	DESCRIPTION	MOQ	MRP
STMT95895-8B	1/4" SD PEAR HEAD RATCHET P9	8	1,049

#### 1/4" ROUND HEAD RATCHET



1/4 Drive

HSN CODE: 82041120

PART No.	DESCRIPTION	MOQ	MRP
STMT86395-8B	1/4" ROUND HEAD RATCHET	4	525

#### 1/4" DRIVE SOCKET

#### 1/4" 6 PT STANDARD SOCKET 3.5MM (HEX)



1/4 Drive

HSN CODE: 82042000

PART No.	SIZE	MOQ	MRP
STMT72873-8B	4MM	18	44
STMT72874-8B	4.5MM	18	44
STMT72875-8B	5MM	18	44
STMT72876-8B	5.5MM	18	44
STMT72877-8B	6MM	18	45
STMT72878-8B	7MM	18	45
STMT72879-8B	8MM	18	46
STMT72880-8B	9MM	15	43
STMT72881-8B	10MM	15	52
STMT72882-8B	11MM	13	56
STMT72883-8B	12MM	8	63
STMT72884-8B	13MM	8	65
STMT72885-8B	14MM	8	74

#### 1/4" DRIVE ACCESSORIES

#### 1/4" ACCESSORIES

STMT91059-8B    STMT86001-8B    STMT86010-8B    STMT86011-8B



1/4 Drive

HSN CODE: 82042000

PART No.	DESCRIPTION	MOQ	MRP
STMT91059-8B	1/4" EXTENSION 50MM	11	82
STMT91339-8B	1/4" EXTENSION 100MM	33	100
STMT86001-8B	1/4" FLEXIBLE EXTENSION 150MM	10	289
STMT86010-8B	1/4" SLIDING TEE	10	199
STMT86011-8B	1/4" UNIVERSAL JOINT	8	162

**3/8" SOCKETS & RATCHETS**

**3/8" DRIVE SOCKET SET**

**46PC 3/8" SQ Dr.DRIVE SOCKET SET**



3/8 Drive

HSN CODE: 82042000

PART No.	DESCRIPTION	MOQ	MRP
89-516	46PC 3/8" SQ Dr.DRIVE SOCKET SET	2	4,695

7 Pc 3/8 Drive 12 Point Socket: 3/8,7/16,1/2,9/16,5/8,11/16,3/4  
 12 Pc 3/8 Drive 12 Point Sockets: Metric-8,9,10,11,12,13,14,15,16,17,18,19mm  
 9 Pc 1/4 Drive Bit Set: Pozidriv Bit-1,2,3mm and Hex Bit-3,4,5,6,7,8mm  
 9 Pc 1/4 Drive Bit Set: Slotted Bits- 4,5,6,5 and Torx® Bits - T10,T15,T20,T30,T40  
 9 Pc 3/8 Drive Accessories: 2 Pc. Spark Plug Socket  
 6 Point Socket: 5/8 and 13/16, 2 Pc Extension Bar-75 and 150mm  
 1 Pc Universal Joint, 1 Pc Adapter  
 1 Pc Full Polish Quick Release Ratchet, 1 Pc 1/4 Drive Bir Adapter  
 1/4 Drive Spinner Handle

**24PC 3/8 SQ.DR. 6PT SOCKET SET**



3/8 Drive

HSN CODE: 82042000

PART No.	DESCRIPTION	MOQ	MRP
1-89-035	24PC 3/8 SQ.DR. 6PT SOCKET SET MET	1	3,916

19 PC 3/8 Drive 6 Point Sockets: 6,7,8,9,10,11,12,13,14,15,16,17,18,19,20,21,22,23,24mm  
 5 PC 3/8 Drive Accessories:  
 Extension: 75, 150mm  
 Universal Joint  
 Sliding T-Bar  
 Professional Ratchet

**3/8" DRIVE SOCKET RATCHET**

**3/8" PEAR HEAD RATCHET**



3/8 Drive

HSN CODE: 82042000

PART No.	DESCRIPTION	MOQ	MRP
STMT95894-8B	3/8" SD PEAR HEAD RATCHET P9	10	1,598

**3/8" ROUND HEAD RATCHET**



3/8 Drive

HSN CODE: 82042000

PART No.	DESCRIPTION	MOQ	MRP
STMT86396-8B	3/8" ROUND HEAD RATCHET	8	688

**3/8" DRIVE SOCKET**

**3/8" 6 PT STANDARD SOCKET (HEX)**



3/8 Drive

HSN CODE: 82042000

PART No.	SIZE	MOQ	MRP
STMT72914-8B	6MM	12	62
STMT72915-8B	7MM	12	62
STMT72916-8B	8MM	12	62
STMT72917-8B	9MM	12	62
STMT72918-8B	10MM	12	62
STMT72919-8B	11MM	12	62
STMT72920-8B	12MM	12	66
STMT72921-8B	13MM	12	66
STMT72922-8B	14MM	11	66
STMT72924-8B	16MM	15	64
STMT72925-8B	17MM	14	78
STMT72927-8B	19MM	11	92
STMT72929-8B	21MM	9	99
STMT72930-8B	22MM	8	112

**3/8" ACCESSORIES**

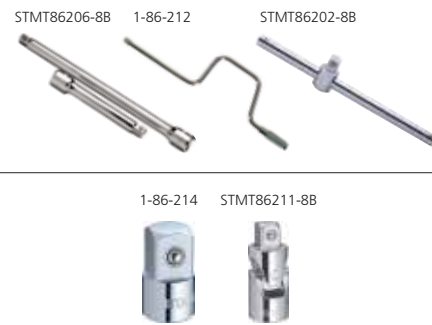

3/8 Drive

HSN CODE: 82042000

PART No.	DESCRIPTION	MOQ	MRP
STMT86206-8B	3/8" EXTENSION 75MM	3	164
STMT86207-8B	3/8" EXTENSION 125MM	8	231
1-86-212	HANDLE SPEEDER 3/8 SQ. DR. 380MM	6	582
STMT86202-8B	3/8" SLIDING TEE HANDLE	4	350
1-86-214	ADAPTER 3/8" DR F*1/4"DR.M	6	90
1-86-215	ADAPTER 3/8 SQ. DR F*1/2 SQ. DR.M	6	115
STMT86211-8B	3/8" UNIVERSAL JOINT	8	189

**3/8" IMPACT SOCKET**



3/8 Drive

HSN CODE: 82042000

PART No.	SIZE	MOQ	MRP
STMT73429-8B	8MM	10	129
STMT73430-8B	9MM	10	129
STMT73431-8B	10MM	10	129
STMT73432-8B	11MM	10	129
STMT73433-8B	12MM	10	129
STMT73434-8B	13MM	10	129
STMT73435-8B	14MM	10	129
STMT73436-8B	15MM	10	129
STMT73437-8B	16MM	10	140
STMT73438-8B	17MM	10	140
STMT73439-8B	18MM	10	140
STMT73440-8B	19MM	10	152
STMT73441-8B	21MM	10	175
STMT73442-8B	22MM	10	193
STMT73443-8B	24MM	10	210

### 1/2" SOCKETS & RATCHETS

#### 1/2" DRIVE SOCKET SET

#### 86PC 1/4 & 1/2 SQ.DR. SOCKET SET-6PT MET



1/2 Drive

HSN CODE: 82042000



PART No.	DESCRIPTION	MOQ	MRP
94-190	86PC 1/4 & 1/2 SQ.DR. SOCKET SET-6PT MET	1	13,276

- 14 PC 1/4 Drive 6 Point Metric Socket: 3,5,4,4,5,5,5,6,7,8,9,10,11,12,13,14mm
- 8 PC 1/4 Drive 6 Point Metric Deep Sockets: 6,7,8,9,10,11,12,13mm
- 2 PC 1/4 and 1/2 Drive Pear Head Ratchet With Comfort Grip
- 2 PC 1/4 Drive Extension Bar: 2,4(50, 100mm)
- 1 PC 1/4 Sliding -Bar : 4(100mm)
- 1 PC 1/4 Drive Bit Spinner
- 1 PC 1/4 Drive Universal Joint
- 1 PC 3/8 Drive Female and 1/2 Drive Male: 3-Way Adapter
- 14 PC 1/2 Drive 6 Point Metric Sockets: 13,14,15,16,17,18,19,20,21,22,23,24,27,30,32mm
- 4 PC 1/2 Drive 6 Point Deep Metric Sockets: 14,16,17,19mm
- 2 PC 1/2 Drive Extension Bar: 5,10 (125,250mm)
- 1 PC Drive Universal Joint
- 1 PC Drive Bit Holder: 5/16
- 2 PC 1/2 Drive 6 Point Spark Plung Metric Sockets: 16,21mm
- 6 PC 1/4 Drive Torx® Bit Sockets: T-8,T-10,T-15,T-25,T-30
- 4 PC 1/4 Drive Hex Bit Sockets: 3,4,5,6mm
- 2 PC 1/4 Drive Phillips® Bit Socket: #1, #2
- 2 PC 1/4 Drive Pozidriv® Bit Socket: #1, #2
- 3 PC 1/4 Drive Slotted Bit Sockets: 4,5,5,6,5mm
- 3 PC 5/16 Drive Slotted® : 8,10,12mm
- 2 PC 5/16 Drive Phillips® BIT : #3,#4
- 2 PC 5/16 Drive Pozidriv®BIT : #3,#4
- 4 PC 5/16 Drive Torx® Bit With Rubber Holder: T-40,T-45,T-50,T-55
- 4 PC 5/16 Drive Hex Bits: 8,10,12,14mm

#### 72 PC 1/4"+1/2" SOCKET SET



1/2 Drive

HSN CODE: 82042000



PART No.	DESCRIPTION	MOQ	MRP
STMT82831-1-12	72 PC 1/4"+1/2" SOCKET SET	1	9,957

- 1x 1/4' 72T bi-material ratchet
- 10x 1/4' sockets (6-points) : 5.5 – 14 mm
- 9x 1/4" long sockets (6-points) : 6 – 14 mm
- 2x 1/4" extensions : 3" – 6", 2x 1/2' extensions : 3" – 10"
- 1x 1/4" universal joint, 1x 1/2' universal joint
- 1x 1/4" bit holder, 2x 1/2' spark plugs : 16 – 21 mm
- 1x 1/4' spinner
- 22x 1/4' bits :PZ1-PZ2-PZ3 – PH1-PH2-PH3 HEX3-4-5-6-7
- Torx10-15-20-25-27-30-40 SLOTTED4-5-6-7
- 1x 1/2' 72T bi-material ratchet
- 19x 1/2' sockets (6-points) : 8 – 32 mm



#### 43PC 1/2 SQ. DR. 12PT SOCKET SET



1/2 Drive

HSN CODE: 82042000



PART No.	DESCRIPTION	MOQ	MRP
89-509	43PC 1/2 SQ. DR. 12PT SOCKET SET MET/IMP	1	9,734

- 15 PC 1/2 Drive 12 Point Sockets: 3/16, 7/16, 1/2, 9/16, 1-1/16, 5/8, 11/16, 3/4, 13/16, 7/8, 15/16, 1, 1-1/8, 1-3/16, 1-1/4.
- 20 PC 1/2 Drive 12 Point Socket:  
Metric-10,11,12,13,14,15,16,17,18,19,20,21,22,23,24,25,26,27, 28,29,30,32mm.
- 8 PC 1/2 Drive Accessories: 2 PC 6 Point Spark Plug Socket: 5/8, and 13/16, Universal Joint,
- 1 PC Flex Handle-375mm, 3 Extension Bars-3,5 and 10(75,125,250),
- 1 PC Full Polish Quick Release Ratchet

#### 25PC 1/2 SQ. DR.12PT SOCKET SET IMP



1/2 Drive

HSN CODE: 82042000



PART No.	DESCRIPTION	MOQ	MRP
86-478	25PC 1/2 SQ. DR.12PT SOCKET SET IMP	1	5,630

- 20 PC 1/2 Drive 12 Point Socket:  
1/4,5/16,3/8,7/16,1/2,9/16,19/32,5/8,11/16,3/4,25/32,13/16  
7/8,15/16,31/32,1-1/16,1-1/8,1-3/16,1-1/4
- 6 PC 1/2 Drive Accessories: 2 Extension Bar: 5 and 10(125,250mm); 1PC Universal Joint,
- 1 PC Spark Plung Socket 6 Point 13/16, 1 Sliding T-bar 10(254mm); PC Flip-drive Ratchet

#### 24 PC 1/2 SQ. DRIVE 6 PT SOCKET SET



1/2 Drive

HSN CODE: 82042000



PART No.	DESCRIPTION	MOQ	CARTON	MRP
STMT72795-8	24 PC 1/2 SQ. DRIVE 6 PT SOCKET SET	1	20	5,128

- 1 PC 1/2 Drive Quick Release Ratchet
- 2 PC 1/2 Drive Extensions: 130 and 250mm
- 1 PC 1/2 Drive Universal Joint
- 1 PC 1/2 Drive Sliding T-handle
- 1 PC 1/2 Drive Spark Plung Sockets 21mm
- 18 PC 1/2 Drive 6 Point Socket-10,11,12,13,14,15,16,17,18,19,20,21,22,23,24,27,30,32mm

#### 27PC-1/2 SQ. DR 12PT SOCKET SET



1/2 Drive

HSN CODE: 82042000



PART No.	DESCRIPTION	MOQ	MRP
86-477	27PC-1/2 SQ. DR 12PT SOCKET SET MET	1	4,884

- 20 PC 1/2 Drive 12 Point Sockets:  
10,11,12,13,14,15,16,17,18,19,20,21,22,23,24,25,26,27,30,32mm
- 6 PC: 1/2 Drive Accessories : 2 PC Extension Bar: 5 and 10(125 and 250mm) Universal Joint,
- 1 PC Spark Plug Socket 6 Point 13/16, 1 PC Sliding T-bar 10(254mm); 1 PC Flip-Drive Ratchet.

**1/2" DRIVE RATCHET**  
**1/2" PEAR HEAD RATCHET**



1/2 Drive

HSN CODE: 82042000



PART No.	DESCRIPTION	MOQ	MRP
STMT95893-8B	1/2" SD PEAR HEAD RATCHET P9	5	1,736

**1/2" ROUND HEAD RATCHET**



1/2 Drive

HSN CODE: 82042000



PART No.	DESCRIPTION	MOQ	MRP
1-86-397	RATCHET 1/2 SQ. DR QUICK RELEASE	4	991

**1/2" FLIP DRIVE RATCHET**



1/2 Drive

HSN CODE: 82041120



PART No.	DESCRIPTION	MOQ	MRP
1-87-720	RATCHET 1/2 SQ. DR. FLIP DRIVE	4	892

**1/2" 6 PT STANDARD SOCKET (HEX)**



1/2 Drive

HSN CODE: 82042000



PART No.	SIZE	MOQ	MRP
1-86-508	8MM	6	77
1-86-509	9MM	6	77
1-86-510	10MM	6	77
1-86-511	11MM	6	77
1-86-512	12MM	6	79
1-86-513	13MM	6	79
1-86-514	14MM	6	79
1-86-515	15MM	6	79
1-88-738	16MM	6	79
1-88-739	17MM	6	85
1-88-740	18MM	6	85
1-88-741	19MM	6	85
1-88-742	20MM	6	99
1-88-743	21MM	4	99
1-88-744	22MM	4	112
1-88-745	23MM	4	112
1-88-746	24MM	4	128
1-88-747	25MM	4	138
1-88-748	26MM	4	144
1-88-749	27MM	4	166
1-88-750	28MM	4	175
1-88-751	29MM	4	181
1-88-752	30MM	2	199
1-88-753	32MM	2	222
1-86-196	34MM	2	257
1-86-536	36MM	2	463

**1/2" 12 PT STANDARD SOCKET (BI-HEX)**



1/2 Drive

HSN CODE: 82042000



PART No.	SIZE	MOQ	MRP
1-86-540	8MM	6	77
1-86-542	10MM	6	77
1-86-543	11MM	6	77
1-86-544	12MM	6	79
1-86-545	13MM	6	79
1-86-546	14MM	6	79
1-86-547	15MM	6	79
1-88-788	16MM	6	79
1-88-789	17MM	6	85
1-88-790	18MM	6	85
1-88-791	19MM	6	85
1-88-792	20MM	4	99
1-88-793	21MM	4	99
1-88-794	22MM	4	112
1-88-796	24MM	4	128
1-88-799	27MM	4	166
1-88-802	30MM	2	199
1-88-803	32MM	2	222
1-86-192	34MM	6	257

**1/2" 6 PT DEEP SOCKET (HEX)**



1/2 Drive

HSN CODE: 82042000



PART No.	SIZE	MOQ	MRP
STMT73324-8B	10MM	7	157
STMT73325-8B	11MM	7	157
STMT73326-8B	12MM	7	157
STMT73327-8B	13MM	7	157
STMT73328-8B	14MM	7	157
STMT73329-8B	15MM	7	163
STMT73330-8B	16MM	6	163
STMT73331-8B	17MM	6	163
STMT73332-8B	18MM	6	174
STMT73333-8B	19MM	4	182
STMT73334-8B	21MM	6	192
STMT73335-8B	22MM	5	220
STMT73336-8B	23MM	5	228
STMT73337-8B	24MM	5	239
STMT73338-8B	27MM	4	305
STMT73339-8B	30MM	2	385
STMT73340-8B	32MM	2	409



### 1/2" DRIVE HEX BIT SOCKET 7PC 1/2 SQ. DR. HEX BIT SOCKET SET



1/2 Drive

HSN CODE: 82042000



PART No.	DESCRIPTION	MOQ	MRP
1-89-099	7PC 1/2 SQ. DR. HEX BIT SOCKET SET MET	1	1,488

7 PC 1/2 Drive Hex Bit Socket: 6,8,10,12,14,17,19mm

### 1/2" HEXAGONAL BIT SOCKET



1/2 Drive

HSN CODE: 82042000



PART No.	SIZE	MOQ	MRP
STMT73371-8B	4 MM	6	128
STMT73372-8B	5 MM	6	128
STMT73373-8B	6 MM	6	128
STMT73374-8B	7 MM	6	128
STMT73375-8B	8 MM	6	128
STMT73376-8B	9 MM	6	135
STMT73377-8B	10 MM	6	141
STMT73378-8B	12 MM	6	158
STMT73379-8B	14 MM	6	203
STMT73380-8B	17 MM	3	234
STMT73381-8B	19 MM	2	292

### 1/2" DRIVE TORX BIT SOCKET 9 PC 1/2" DR TORX BIT SOCKET SET



1/2 Drive

HSN CODE: 82042000



PART No.	DESCRIPTION	MOQ	MRP
89-098	9 PC 1/2" DR TORX BIT SOCKET SET	1	1,633

9 PC 1/2 Drive Torx® Bit Socket Set-Metric-T-20,T-25,T-27,T-30,T-40,T-45,T-50,T-55,T-60

### 1/2" TORX BIT SOCKET



1/2 Drive

HSN CODE: 82042000



PART No.	SIZE	MOQ	MRP
STMT73389-8B	T20	6	146
STMT73390-8B	T25	6	146
STMT73391-8B	T27	6	146
STMT73392-8B	T30	6	146
STMT73393-8B	T40	6	146
STMT73394-8B	T45	6	153
STMT73395-8B	T50	6	153
STMT73396-8B	T55	6	189
STMT73397-8B	T60	6	194

### 1/2" DRIVE SOCKET ACCESSORIES 1/2" ACCESSORIES



1/2 Drive

HSN CODE: 82042000



PART No.	DESCRIPTION	MOQ	MRP
1-86-405	FLEX HANDLE 1/2 SQ. DR. 250MM-10"	4	692
STMT88930-8B	1/2" EXTENSION 75MM	5	175
STMT86407-8B	1/2" EXTENSION 125MM	6	222
STMT86408-8B	1/2" EXTENSION 250MM	12	339
1-86-440	SLIDING TEE 1/2 SQ	4	471
1-86-414	ADAPTER 1/2" DR F*3/8"M	6	126
1-88-558	ADAPTER 1/2 SQ. DR. F*3/4 SQ. DR. M	6	233
STMT86411-8B	1/2" UNIVERSAL JOINT	10	289

### 1/2" DRIVE IMPACT SOCKET SET 13 PC 1/2" STD IMPACT SOCKET SET



1/2 Drive

HSN CODE: 82042000



PART No.	DESCRIPTION	MOQ	MRP
STMT73916-8	13PC 1/2" Std IMPACT SOCKET SET 10, 11, 12, 13, 14, 15, 16, 17, 18, 19, 21, 22, 24MM	1	2,886

### 1/2" IMPACT DEEP SOCKET



1/2 Drive

HSN CODE: 82042000



PART No.	SIZE	MOQ	MRP
STMT91379-8B	12MM	10	327
STMT87501-8B	14MM	10	322
STMT87504-8B	17MM	10	377
STMT87506-8B	19MM	10	388
STMT87507-8B	21 MM	10	512





**1/2" DRIVE IMPACT SOCKET**  
**1/2" IMPACT SOCKET**



1/2 Drive

HSN CODE: 82042000

PART No.	SIZE	MOQ	MRP
STMT89435-8B	8MM	10	170
STMT89436-8B	9MM	10	170
STMT89437-8B	10MM	10	170
STMT89438-8B	11MM	10	170
STMT89439-8B	12MM	10	170
STMT89440-8B	13MM	10	170
STMT89441-8B	14MM	10	170
STMT89442-8B	15MM	10	170
STMT89443-8B	16MM	10	170
STMT89444-8B	17MM	10	170
STMT89445-8B	18MM	10	170
STMT89446-8B	19MM	10	182
STMT89447-8B	20MM	10	205
STMT89448-8B	21MM	10	205
STMT89449-8B	22MM	10	240
STMT89450-8B	23MM	10	269
STMT89451-8B	24MM	10	269
STMT89452-8B	25MM	10	292
STMT89453-8B	26MM	10	292
STMT89454-8B	27MM	10	327
STMT89455-8B	28MM	10	368
STMT89456-8B	30MM	10	397
STMT89457-8B	31MM	10	426
STMT89458-8B	32MM	10	426

**3/4" SOCKETS & RATCHETS**

**3/4" DRIVE SOCKET**

**19 PC 3/4" DR METRIC 12 POINT SOCKET SET**



3/4 Drive

HSN CODE: 82042000

PART No.	DESCRIPTION	MOQ	MRP
89-101	19 PC 3/4" DR METRIC 12 POINT SOCKET SET	1	14,310

13 PC 3/4 Drive 12 Point Sockets: 22,24,27,28,29,30,32,33,34,36,38,41,42,46,50mm  
4 PC 3/4 Drive Accessories; 2 PC Extension Bar: 200 and 400mm sliding T-bar 480mm Standard Ratchet.

**3/4" RATCHET WITH HANDLE**



3/4 Drive

HSN CODE: 82042000

PART No.	DESCRIPTION	MOQ	MRP
STMT91316-8B	3/4" RATCHET WITH HANDLE	2	2,912



**3/4" 6PT SOCKET (HEX)**



3/4 Drive

HSN CODE: 82042000

PART No.	SIZE	MOQ	MRP
STMT89319-8B	19MM	4	410
STMT89322-8B	22MM	4	410
STMT89324-8B	24MM	4	410
STMT89325-8B	25MM	4	424
STMT89327-8B	27MM	4	441
STMT89328-8B	28MM	4	448
STMT89330-8B	30MM	4	484
STMT89332-8B	32MM	4	547
STMT89333-8B	33MM	4	560
STMT89334-8B	34MM	4	560
STMT89336-8B	36MM	4	696
STMT89338-8B	38MM	4	744
STMT89341-8B	41MM	4	822
STMT89346-8B	46MM	4	889
STMT89350-8B	50MM	4	1,007

**3/4" 12 PTS SOCKET (BI-HEX)**



3/4 Drive

HSN CODE: 82042000

PART No.	SIZE	MOQ	MRP
STMT89619-8B	19MM	4	410
STMT89624-8B	24MM	4	410
STMT89627-8B	27MM	4	441
STMT89628-8B	28MM	4	448
STMT89630-8B	30MM	4	484
STMT89636-8B	36MM	4	696
STMT89638-8B	38MM	4	701
STMT89650-8B	50MM	4	1,007
STMT89655-8B	55MM	4	1,279

**3/4" ACCESSORIES**

STMT89302-8B      STMT89307-8B      STMT89303-8B



STMT88908-8B      STMT93091-8B



3/4 Drive

HSN CODE: 82042000

PART No.	DESCRIPTION	MOQ	MRP
STMT89302-8B	3/4" SWIVEL HANDLE	2	2,446
STMT89307-8B	3/4" EXTENSION 200MM	4	1,049
STMT89308-8B	3/4" EXTENSION 400MM	2	1,724
STMT89303-8B	3/4" SLIDING TEE	2	1,619
STMT88908-8B	ADAPTER 3/4" DR F TO 1/2" DR M	4	292
STMT93091-8B	3/4" UNIVERSAL JOINT	4	1,864



**TORQUE WRENCH**

**STANLEY TORQUE WRENCH**

**1/4" & 3/8" RATCHETING TYPE TORQUE WRENCH**

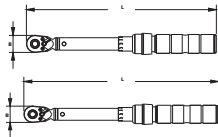

- ISO 6789, ASME B107.14
- Accuracy: +/- 4%
- Visual and audible indication
- Dual way direction (C.W./C.C.W.) click type
- Quick release button
- Adjusting ring locking system
- Aluminium alloy handle with anodic treatment
- Si-Cr-Mo spring
- Cr-Mo pawl
- Cr-Mo square driver
- 48 Gear teeth



HSN CODE: 82041120  
MOQ:1

SKU #	DESCRIPTION	DRIVER SIZE	TORQUE RANGE	TORQUE RANGE	INCREMENT	B (mm)	L (mm)	WEIGHT (Kg)	MRP
STMT73587-8	1/4" TORQUE WRENCH 5-25 NM	1/4"	5-25 N-m	48.7-225.7 in-lb	0.1 N-m	22.5	246	0.365	9,306
STMT73588-8	3/8" TORQUE WRENCH 10-50NM	3/8"	10-50 N-m	9.2-38.7 Ft-lb	0.5 N-m	31	409	1.182	9,881

**1/2" RATCHETING TYPE TORQUE WRENCH**

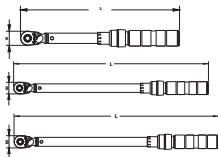

- ISO 6789, ASME B107.14
- Accuracy: +/- 4%
- Visual and audible indication
- Dual way direction (C.W./C.C.W.) click type
- Dual scale (N-m & in-lb.)
- Quick release button
- Adjusting ring locking system
- Aluminium ring locking system
- Aluminium alloy handle with anodic treatment
- Si-Cr-Mo spring
- Cr-Mo pawl
- Cr-Mo square driver
- 48 Gear teeth



HSN CODE: 82041120  
MOQ:1

SKU #	DESCRIPTION	DRIVER SIZE	TORQUE RANGE	TORQUE RANGE	INCREMENT	B (mm)	L (mm)	WEIGHT (Kg)	MRP
STMT73589-8	1/2" TORQUE WRENCH 20-100NM	1/2"	20-100 N-m	16.6-75.6 FT-lb	0.5 N-m	31	409	1.19	10,161
STMT73590-8	1/2" TORQUE WRENCH 40-200NM	1/2"	40-200 N-m	33.2-151.2 FT-lb	1 N-m	41	519	1.6	11,306
STMT73591-8	1/2" TORQUE WRENCH 60-340NM	1/2"	60-340 N-m	51.6-258.1 FT-lb	2 N-m	41	610	1.785	11,871

**3/4" RATCHETING TYPE TORQUE WRENCH**

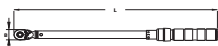

- ISO 6789, ASME B107.14
- Accuracy: +/- 4%
- Visual and audible indication
- Dual way direction (C.W./C.C.W.) click type
- Quick release button
- Adjusting ring locking system
- Aluminium alloy handle with anodic treatment
- Si-Cr-Mo spring
- Cr-Mo pawl
- Cr-Mo square driver
- 48 Gear teeth



HSN CODE: 82041120  
MOQ:1

SKU #	DESCRIPTION	DRIVER SIZE	TORQUE RANGE	TORQUE RANGE	INCREMENT	B (mm)	L (mm)	WEIGHT (Kg)	MRP
STMT73592-8	3/4" TORQUE WRENCH 150-750 NM	3/4"	150-750 N-m	110-550 Ft-lb	2.5 N-m	58	1112	5.87	39,063

**BRITOOOL TORQUE WRENCH**

**3/8" CLASSIC TORQUE WRENCH**



HSN CODE: 82041120

PART No.	DESCRIPTION	TORQUE RANGE	LENGTH	MOQ	MRP
AVT100A	3/8" SQ. DR. TORQUE WRENCH	(2.5-11Nm)	318MM	1	13,987
AVT300A	3/8" SQ. DR. TORQUE WRENCH	(5-33Nm)	422MM	1	14,208

**1/2" CLASSIC TORQUE WRENCH**



HSN CODE: 82041120

PART No.	DESCRIPTION	TORQUE RANGE	LENGTH	MOQ	MRP
EVT600A	1/2" SQ DR TORQUE WRENCH	12-68Nm	476MM	1	14,875
EVT1200A	1/2" SQ DR TORQUE WRENCH	25-135Nm	546MM	1	15,797
EVT2000A	1/2" SQ DR TORQUE WRENCH	50-225Nm	597MM	1	16,479
EVT3000A	1/2" SQ DR TORQUE WRENCH	70-330Nm	825MM	1	18,725

**3/4" & 1" CLASSIC TORQUE WRENCH**



HSN CODE: 82041120

PART No.	DESCRIPTION	TORQUE RANGE	LENGTH	MOQ	MRP
HVT5000	3/4" SQ DR TORQUE SPANNER	140-560Nm	1130MM	1	45,540
HVT7200	3/4" SQ DR TORQUE SPANNER	200-810Nm	1181MM	1	46,543
GVT8400	1" SQ DR TORQUE SPANNER	480-940Nm	1397MM	1	76,057

**ACCESSIBILITY**  
Compact design ideal for restricted access

**DURABILITY**  
Proven to be one of the most robust products in the market, the first choice for arduous conditions

**ACCURACY**  
Exceeds requirements of ISO 6789

**SCALE**  
Multiple scales – Nm, kg.m, lbf.in and lbf.ft are branded into steel tube, giving reliability for the life of the product

**FLEXIBILITY**  
Push-through square drive for left- and right-hand operation

**SETTING**  
Retractable adjuster knob cannot be altered by accident

**SERVICE**  
Fully repairable with dedicated service kits

**IMPACT WRENCH**

**1/2" MINI IMPACT WRENCH**

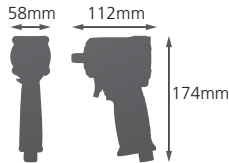

HSN CODE: 82041120  
MOQ:1

- One hand rotation switch – forward/reverse for either left or right handed users
- Speed control – one hand operation with 3 position disc switch
- Compact aluminum for better access in tight areas
- Durable jumbo hammer
- Ergonomic handle
- High working torque
- Durable and light weight
- Ergonomically engineered
- Weight 1.2 kg

**1/2"DR.**  
**678**  
MAX TORQUE N.m

SKU #	DESCRIPTION	ANVIL (inch)	MAX TORQUE (N.m)	FREE SPEED (RPM)	AVERAGE AIR CONSUMPTION (CFM)	AIR PRESSURE (PSI)	HOSE SIZE (inch)	MRP
STMT74840-800	1/2" MINI IMPACT WRENCH	1/2"	678	10,000	5.3	90	3/8"	16,351

**1/2" IMPACT WRENCH**

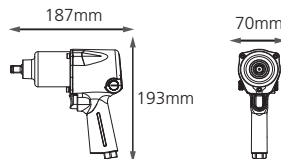

- Patented hammer case improving durability
- 5 speeds forward and reverse
- Balanced weight design and handle exhaust directs air away
- Hammering mechanism: twin hammer
- Vibration: 5.20 m/s<sup>2</sup>
- Noise level: 95 db under no load
- Housing: alum
- Exhaust: handle
- Air inlet: 1/4"
- Weight 2.58 kg

HSN CODE: 82042000  
MOQ:1

**1/2"DR.**  
**610**  
MAX TORQUE N.m



SKU #	DESCRIPTION	ANVIL (inch)	MAX TORQUE (N.m)	FREE SPEED (RPM)	AVERAGE AIR CONSUMPTION (CFM)	AIR PRESSURE (PSI)	HOSE SIZE (inch)	MRP
STMT99300-8	1/2" IMPACT WRENCH 610 N-m (450 ft-lbs)	1/2"	610	7,500	3.9	90	3/8"	12,908

**3/8" IMPACT WRENCH**



- 5 Speeds forward and reverse
- Compact design for light torque applications
- Hammering mechanism: jumbo hammer
- Vibration: 3.0 m/s<sup>2</sup>
- Noise level: 86.0 db under no load
- Housing: Alum.
- Exhaust: Handle
- Air Inlet: 1/4"
- Weight 1.27 kg

HSN CODE: 82042000  
MOQ:1



SKU #	DESCRIPTION	ANVIL (inch)	MAX TORQUE (N.m)	FREE SPEED (RPM)	AVERAGE AIR CONSUMPTION (CFM)	AIR PRESSURE (PSI)	HOSE SIZE (inch)	MRP
STMT70116-8	3/8" IMPACT WRENCH 244 N-m (180 ft-lbs)	3/8"	244	9,000	3.1	90	3/8"	9,545

**3/4" IMPACT WRENCH**



- High Performance Motor Maximizes Power Output  
With Full Power In Reverse; Adjustable Power In Forward
- Balanced weight design and handled exhaust directs air away from the user
- Designed for fleet and truck service work
- Rotator: Pin clutch
- Vibration: 5.50 m/s<sup>2</sup>
- Noise level: 96.2 under no load
- Housing: Alum.
- Exhaust: Handle
- Air Inlet: 1/4"
- Weight 5.72 kg

HSN CODE: 82042000  
MOQ:1



SKU #	DESCRIPTION	ANVIL (inch)	MAX TORQUE (N.m)	FREE SPEED (RPM)	AVERAGE AIR CONSUMPTION (CFM)	AIR PRESSURE (PSI)	HOSE SIZE (inch)	MRP
STMT97134-8	3/4" MINI IMPACT WRENCH 1492 N-m (1.100 Ft-lb)	3/4"	1492	3,600	4.0	90	1/2"	24,689

**AIR RATCHET**

**1/2" AIR RATCHET**

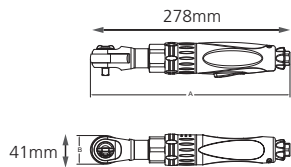

- Double ratchet pawls increase durability and tool life
- Enlarged forward and reverse switch
- Comfort rubber grip
- Exhaust: 3600 adjustable exhaust directs away from the user
- Noise level: 88.50 dB under no load
- Air Inlet: 1/4"



HSN CODE: 82042000  
MOQ:1

SKU #	DESCRIPTION	ANVIL (inch)	MAX TORQUE (N.m)	FREE SPEED (RPM)	AVERAGE AIR CONSUMPTION (CFM)	AIR PRESSURE (PSI)	HOSE SIZE (inch)	MRP
STMT78056-8	1/2" AIR RATCHET WRENCH 81.4 N-m (60 ft-lbs)	1/2"	81.4	180	3.9	90	3/8"	6,190

**3/8" AIR RATCHET**

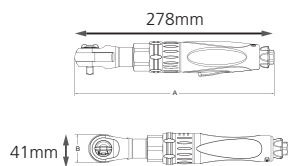

- Double ratchet pawls increase durability and tool life
- Enlarged forward and reverse switch
- Comfort rubber grip
- Exhaust: 3600 adjustable exhaust directs air away from the user
- Rotator: Double Pawl
- Vibration: 3.73 m/s<sup>2</sup>
- Noise level: 88.50 dB under no load
- Air Inlet: 1/4"



HSN CODE: 82042000  
MOQ:1

SKU #	DESCRIPTION	ANVIL (inch)	MAX TORQUE (N.m)	FREE SPEED (RPM)	AVERAGE AIR CONSUMPTION (CFM)	AIR PRESSURE (PSI)	HOSE SIZE (inch)	MRP
STMT78401-8	3/8" RATCHET WRENCH 81.4 N-m (60 ft-lbs)	3/8"	81.4	180	3.9	90	3/8"	5,790

**SPECIALITY TOOLS**

**SPECIALITY TOOLS**

**3 JAW GEAR PULLER**

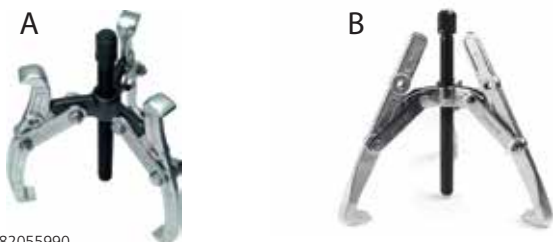

HSN CODE: 82055990

PART No.	DESCRIPTION	IMAGE	MOQ	MRP
70746-S	75MM	A	1	2,214
70747-S	100MM	A	1	3,261
70748-S	150MM	A	1	4,631
70875-S	200MM	B	1	4,879
70876-S	250MM	B	1	9,379
70877-S	300MM	B	1	13,974

**FEELER GAUGE**



HSN CODE: 90173029

PART No.	SIZE	MOQ	MRP
70115-S	FEELER GAUGE 25 BLADES (0.04, 0.05, 0.06, 0.07, 0.08, 0.09, 0.10, 0.15, 0.20, 0.25, 0.30, 0.35, 0.40, 0.45, 0.50, 0.55, 0.60, 0.65, 0.70, 0.75, 0.80, 0.85, 0.90, 0.95, 1.00MM)	1	642

**OIL FILTER SPANNER STRAP TYPE**



HSN CODE: 82041120

PART No.	SIZE	MOQ	MRP
997694-S	OIL FILTER WRENCH STRAP TYPE	1	826

**EXTRACTORS SET**



HSN CODE: 82055990

PART No.	SIZE	MOQ	MRP
94-171	5PC. EXTRACTORS SET - (3, 6, 8, 11, 14MM)	1	537

**BOTTLE JACK**



HSN CODE: 84254200

PART No.	DESCRIPTION	MOQ	MRP
ST90801CE	8000KG-8 TON	4	4,076
ST92001CE	20000KG-20 TON	2	6,755
ST-93001CE	30000KG-30 TON	1	16,885
ST-95001CE	50000KG-50 TON	1	24,455

**FLAT TYRE REPAIR KIT**



- Easily repair the punctures without removing the tyre from the rim
- Sturdy handle for added leverage
- Includes 5 repair strings

HSN CODE: 82059030

PART No.	SIZE	MOQ	MRP
STHT80891-0	FLAT TYRE REPAIR KIT	6	530



**FOOT PUMP**



- High Pressure Cylinder Foot Pump
- Can be used for cars, bikes, balloons etc., (adapters included)
- Compact Size - No need too much room in your car
- Lightweight about 1kg

HSN CODE: 84142010

PART No.	SIZE	MOQ	MRP
STHT80894-1	FOOT PUMP	1	1,229



**DIGITAL TIRE PRESSURE GAUGE  
ELECTRONIC DEVICES**



- Easy to Read Digital Display
- Comfort Grip Handle
- Made of Automotive Chemical Resistant Materials
- Integrated LED for Use at Night or Dark Areas
- 0.5 PSI Resolution
- Batteries Included

HSN CODE: 90173029

PART No.	DESCRIPTION	MOQ	MRP
STHT80874-0	DIGITAL TIRE PRESSURE GAUGE	1	1,229

**PAIR OF 2T AXLE STANDS**



- 2T axle stands
- Min height: 278MM / Max Height: 430MM
- Safety pins
- Foot pads for more stability
- High quality ratchet bar to work in safety conditions

HSN CODE: 82042000

PART No.	SIZE	MOQ	MRP
STMT81255-1	PAIR OF 2T AXLE STANDS	1	4,076

**GREASE GUN HEAVY DUTY**



HSN CODE: 82055910

PART No.	SIZE	MOQ	MRP
95-385-2V	GREASE GUN HEAVY DUTY - 400GM	1	1,083

**TELESCOPIC MAGNETIC PICK-UP TOOL**



HSN CODE: 84679900

PART No.	SIZE	MOQ	MRP
STHT25114-0	ST TELESCOPIC MAGNETIC PICK-UP TOOL	5	599

**PRECISION AIR GUN**



HSN CODE: 82055910

PART No.	SIZE	MOQ	MRP
79-058	PRECISION AIR GUN 4 IN	6	649

**ROUND INSPECTION MIRROR**



HSN CODE: 90178090

PART No.	SIZE	MOQ	MRP
STMT78241-8	ROUND INSPECTION MIRROR	24	385





### INSULATED TOOLS

#### INSULATED TOOL SET

#### VDE SCREWDRIVER SET

**NEW**  
 100%  
 100%  
 100%



HSN CODE: 82054000

PART No.	DESCRIPTION	MOQ	MRP
STMT60175	7PCS VDE SCREWDRIVER SET	1	2,477

#### VDE 3PCS PLIERS SET



HSN CODE: 82032000

PART No.	DESCRIPTION	MOQ	MRP
84-011	VDE 3PCS SET (84-001,003,007)	1	4,426

### INSULATED TOOLS

#### VDE COMBINATION PLIER



HSN CODE: 82032000

OLD PART No.	PART No.	DESCRIPTION	MOQ	MRP
0-84-001	84-001	VDE COMBINATION PLIER 175MM	4	1,614
0-84-002	84-002	VDE COMBINATION PLIER 200MM	8	2,330

#### VDE DIAGONAL PLIER



HSN CODE: 49111020

OLD PART No.	PART No.	DESCRIPTION	MOQ	MRP
0-84-003	84-003	VDE DIAGONAL PLIER 175MM	10	2,330

#### VDE LONG NOSE PLIER



HSN CODE: 82032000

OLD PART No.	PART No.	DESCRIPTION	MOQ	MRP
0-84-006	84-006	VDE LONG NOSE PLIER 160MM	10	1,392

#### VDE BENT NOSE PLIER



HSN CODE: 82032000

OLD PART No.	PART No.	DESCRIPTION	MOQ	MRP
0-84-008	84-008	VDE BENT NOSE PLIER 200MM	10	1,590

#### VDE WIRE STRIPPER PLIER



HSN CODE: 82032000

OLD PART No.	PART No.	DESCRIPTION	MOQ	MRP
0-84-010	84-010	VDE WIRE STRIPPER PLIER 170MM	4	1,474

#### VDE WATER PUMP PLIER



HSN CODE: 82032000

OLD PART No.	PART No.	DESCRIPTION	MOQ	MRP
0-84-294	84-294	VDE WATER PUMP PLIER 255MM	4	1,852



**LASER MEASURING DEVICES**

**ROTARY LASER LEVEL - RED**



INCLUDES: 1 BATTERY - 18V XR, BATTERY CHARGER, DETECTOR, WALL BRACKET, TARGET BOARD, GLASSES, SUITCASE T-STAK



HSN CODE: 84672100

PART No.	DESCRIPTION	MOQ	MRP
DCE074D1R-QW	ROTARY LASER WITH DETECTOR & ACCS.	1	88,965

**OPTICAL LEVELS**

**OPTICAL LEVEL AL24G & OPTICAL LEVEL AL32**

1-77-182



1-77-238



- 32X Magnification - 1-77-238
- 24X Magnification - 1-77-182
- Wire hung magnetically dampened compensator for optimum transit lock for accuracy & range"
- Compensator lock protects instrument during transport or storage; the lock can be used as a handy compensator checking tool.
- Large effective aperture with 30cm minimum focal range
- Top mounted optical peep-sight for quick reference.
- Large easy to use precise focusing knob.
- Easy-to-read horizontal circle.
- Penta prism for easy bubble viewing.
- Sealed, dust-protected leveling screws.

HSN CODE: 82059030

PART No.	DESCRIPTION	MOQ	MRP
1-77-182	OPTICAL LEVEL AL24G AUTOMATIC (DEGREES)	1	15,488
1-77-159N	AL24G OPTICAL LEVEL - SITE PACK SET WITH TRIPOD AND STAFF	1	23,523
1-77-238	OPTICAL LEVEL AL32XL AUTOMATIC (DEGREES)	1	18,632

1-77-159N



### OPTIC ACCESSORIES OPTICAL LEVEL TRIPOD & MEASURING STAFF



HSN CODE: 73269099

PART No.	DESCRIPTION	MOQ	MRP
STHT77625-1	TRIPOD FOR OPTICAL LEVEL (74-150CM)	1	4,018
1-77-162	ALUMINIUM MEASURING STAFF 5M GD-II	1	4,076
1-77-163	TRIPOD FOR OPTICAL LEVEL (97-162 CM)	1	4,659



### LASER MEASURER DEVICES LASER DISTANCE MEASURER 100M LASER DISTANCE MEASURER

DEWALT



HSN CODE: 90178090

PART No.	SIZE	MOQ	MRP
DW03101-XJ	100M LASER DISTANCE MEASURER	1	17,992

### 50M LASER DISTANCE MEASURER

DEWALT



HSN CODE: 90178090

PART No.	SIZE	MOQ	MRP
DW0165N	50M LASER DISTANCE MEASURER	1	9,084

### 30M LASER DISTANCE MEASURER

DEWALT

DW033-XJ



HSN CODE: 90178090

PART No.	SIZE	MOQ	MRP
DW033-XJ	30M LASER DISTANCE MEASURER	1	4,868

### 16M POCKET LASER DISTANCE METER

DEWALT

NEW



HSN CODE: 90178090

PART No.	SIZE	MOQ	MRP
DW055PL-XJ	DEWALT POCKET LASER	2	3,187

### LASER LEVEL

#### STANLEY LASER LEVEL 2-IN-1 LASER STUD FINDER & LASER LEVEL

0-77-260



- Detects metal and live wires in walls
- LED display with continuous live wire detection, thumb dial adjustable feet for leveling the laser
- Locates studs on horizontal and vertical surfaces; 180° pivoting laser plane with level and plumb vials
- Laser Line Accuracy: 12 mm @ 6m
- Laser Line Range: Up to 6m line projection onto work surface with 90° squaring.

HSN CODE: 90178090

PART No.	DESCRIPTION	MOQ	MRP
0-77-260	2-IN-1 LASER STUD FINDER & LASER LEVEL	1	4,426



**CUBIX CROSS LINE LASER - RED & GREEN**

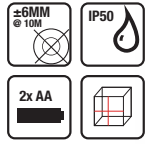

STHT77498-1 STHT77499-1

Includes removable quick-link bracket, protective pouch and batteries

HSN CODE: 90178090

PART No.	DESCRIPTION	MOQ	MRP
STHT77498-1	CUBIX CROSS LINE LASER - RED	2	6,173
STHT77499-1	CUBIX CROSS LINE LASER - GREEN	2	10,365

**CROSS LINE LASER - RED**

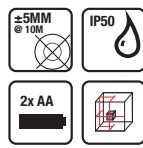

Includes removable quick-link bracket, protective pouch and batteries

HSN CODE: 73269099

PART No.	DESCRIPTION	MOQ	MRP
STHT77502-1	CROSS90 - CROSS LINE LASER WITH 90DEG LINE- RED	2	9,433

**STANLEY LASER LEVEL MULTILINE LASER - 4V1H**

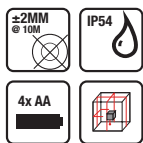

HSN CODE: 73269099

PART No.	DESCRIPTION	MOQ	MRP
STHT77514-1	STANLEY MULTILINE LASER - 4V1H	1	12,461

**DEWALT LASER LEVEL CROSS LINE LASER - RED**

DEWALT

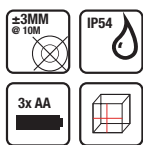

HSN CODE: 82042000

PART No.	DESCRIPTION	MOQ	MRP
DW088K-XJ	DEWALT CROSS LINE LASER - RED	1	13,128

**CROSS LINE LASER - GREEN**

DEWALT

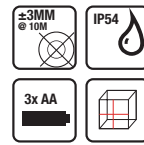

HSN CODE: 73269099

PART No.	DESCRIPTION	MOQ	MRP
DW088CG-XJ	DEWALT GREEN BEAM CROSS LINE LASER	1	20,115

**3 POINTS MULTILINE BEAM LASER**

DEWALT

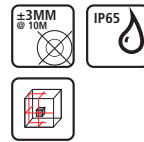

HSN CODE: 73269099

PART No.	DESCRIPTION	MOQ	MRP
DW089K-XJ	3 BEAM LASER - MULTILINE	1	34,935

**MULTI-BEAM 5 PT LASER POINTER+1 BACKLINE**

DEWALT

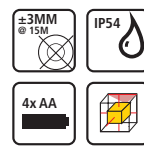

HSN CODE: 84679900

PART No.	DESCRIPTION	MOQ	MRP
DW085K	MULTI-BEAM 5 POINTS LASER POINTER + 1 BACKLINE	1	22,475

**DW 5 PT LASER WITH CROSS BEAM - RED**

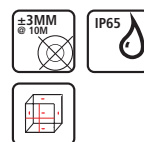

HSN CODE: 73269099

Includes Bracket, glasses, target card and case

PART No.	DESCRIPTION	MOQ	MRP
DCE0825D1R-QW	DW 5 PT LASER WITH CROSS BEAM - RED	1	32,838

### 10.8V MULTILINE LASER - RED

DEWALT

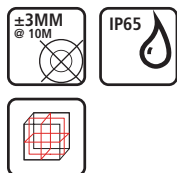

HSN CODE: 73269099

PART No.	DESCRIPTION	MOQ	MRP
DCE089D1R-QW	DW MULTILINE LASER 10.8V - RED	1	48,696

### 10.8V MULTILINE LASER - GREEN

DEWALT

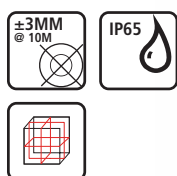

HSN CODE: 73269099

PART No.	DESCRIPTION	MOQ	MRP
DCE089D1G-QW	DW MULTILINE LASER 10.8V - GREEN	1	64,576

### LASER ACCESSORIES LASER DETECTOR

DEWALT



Grade	INDICATORS				
	Above	Slightly Above	On	Slightly Below	Below
Audible Signals	Fast Beep	Fast Beep	Steady Beep	Slow Beep	Slow Beep
Display Icons					

HSN CODE: 82054000

PART No.	DESCRIPTION	MOQ	MRP
DE0892-XJ	RED LASER DETECTOR (DW088K/DW089K)	1	10,132
DE0892G-XJ	GREEN LASER DETECTOR (DW088CG/DCE089)	1	10,714

### MULTI-PURPOSE TRIPOD

DEWALT



- Height: 182 Cms; Weight 1.36 Kgs
- Aluminum construction and 1/4" X 20 Thread mount
- Carrying pouch included
- Collapsible legs, Non-skid feet
- Removable thread mount connector
- Tilting head with integrated level

HSN CODE: 85441920

PART No.	SIZE	MOQ	MRP
DW0881T	DEWALT MULTI-PURPOSE TRIPOD WITH TILTING HEAD	1	3,786

### ELECTRONIC DEVICES

#### MOISTURE METER



- Measures wood moisture from 6% to 44% and masonry (mortar, concrete, plaster) moisture from 0.2% to 2.0%
- Two detection pins (8mm length) to locate in material being tested
- LCD display indicating the moisture level on a bar graph
- Test sockets supplied in the cap
- Operates at 80% humidity

HSN CODE: 90258090

PART No.	DESCRIPTION	MOQ	MRP
0-77-030	STANLEY MOISTURE METER	1	3,518

#### STUD SENSOR

STHT77588-0

- Detects wood and metal studs at 1-1/2" depth & live wires.
- LED lights indicate stud direction and location.
- Auto-calibration for accuracy



FMHT0-77407

- Detects wood/metal studs up to 38mm.
- LCD backlight screen to see the centre of stud.
- Audible sound to indicate stud centre and AC live wires (+ led).
- Auto-calibration for accuracy

HSN CODE: 85452000

PART No.	DESCRIPTION	MOQ	MRP
STHT77588-0	STANLEY STUD SENSOR S160 - 1.5 INCH	1	2,634
FMHT0-77407	FATMAX STUD FINDER S300 - 3 INCH	1	3,142

#### INFRARED THERMOMETER

STHT0-77365



- IP 20 for dust protection
- Wrist band
- 8:1 Spot Ratio
- High contrast, back-light display
- Range of -38°C to 520°C

HSN CODE: 90251910

PART No.	DESCRIPTION	MOQ	MRP
STHT0-77365	INFRARED THERMOMETER - UPTO 520 DEG CELSIUS	1	4,699



**MEASURING TOOLS**

**MEASURING TAPES**

**TYLON SHORT TAPE RULE**



HSN CODE: 90178010

PART No.	SIZE	STANDOUT	MOQ	MRP
STHT43067-12	5MX19MM	1.7M	6	408
STHT43066-12	3MX13MM	1.1M	6	291

**STANLEY SHORT TAPE RULE**



HSN CODE: 90178090

PART No.	SIZE	MOQ	CARTON	MRP
STHT36127-812	5M/16' X 19MM	10	120	154
STHT36125-812	3M/10' X 13MM	10	180	101

**MW40M MEASURING WHEEL**



HSN CODE: 90152000

PART No.	SIZE	MOQ	MRP
1-77-174	318MM-12	1	4,018

**LAYOUT TOOLS**

**LEVELS**

**FATMAX TORPEDO LEVEL PREMIUM**



HSN CODE: 90178090

OLD PART No.	DESCRIPTION	MOQ	MRP
43-609I	9" FATMAX XTREME TORPEDO LEVEL	6	2,261

**TORPEDO LEVEL**



HSN CODE: 90178090

OLD PART No.	DESCRIPTION	MOQ	MRP
STHT42465-812	STANLEY 9" DIE CAST TORPEDO LEVEL	6	653
STHT42264-812	9INCH PLASTIC MAGNETIC	6	349

**STANLEY CLASSIC BOX LEVEL**



HSN CODE: 90178090

OLD PART No.	SIZE	MOQ	MRP
STHT43118-812	30CM	10	909
STHT43103-812	60CM	10	1,259
STHT43105-812	100CM	10	1,806
STHT43106-812	120CM	10	2,184

**LEVEL I-BEAM**



HSN CODE: 90178090

PART No.	SIZE	MOQ	MRP
STHT42072-8	300MM-12" WITH 3 VIALS	20	374
STHT42074-8	600MM-24 WITH 3 VIALS	10	642
STHT42075-8	900MM-36 WITH 3 VIALS	10	827
STHT42076-8	1200MM-48 WITH 3 VIALS	10	1,200

**MET DIECAST COMB SQUARE**



HSN CODE: 90172090

PART No.	DESCRIPTION	MOQ	MRP
2-46-028	300MM MET DIECAST COMB SQUARE	1	1,357

**CHALK LINE**

**CHALK LINE SET**



HSN CODE: 90178090

PART No.	DESCRIPTION	MOQ	MRP
47-443	30M CHALK LINE SET	2	502
0-47-465	30 M POWERWINDER CHALKLINE SET	1	552

**CHALK POWDER**



STHT47403-8

STHT47404-8

HSN CODE: 82042000

PART No.	DESCRIPTION	MOQ	MRP
STHT47403-8	CHALK BLUE 113 gms	1	111
STHT47404-8	CHALK RED 113 gms	1	111

### CUTTING TOOLS

#### KNIVES & BLADES

##### SAFETY UTILITY KNIFE SELF LOCK



HSN CODE: 82081000



PART No.	DESCRIPTION	MOQ	MRP
10-189C	SAFETY UTILITY KNIFE SELF LOCK	6	488

##### CLASSIC 99 RETRACTABLE UTILITY KNIFE



HSN CODE: 73181500



PART No.	DESCRIPTION	MOQ	MRP
10-099	CLASSIC 99 RETRACTABLE UTILITY KNIFE	6	353

##### RETRACTABLE UTILITY KNIFE



HSN CODE: 82081000

PART No.	DESCRIPTION	MOQ	MRP
10-175	RETRACTABLE UTILITY KNIFE, 156MM	6	374

##### FIXED UTILITY KNIFE



HSN CODE: 82081000

PART No.	DESCRIPTION	MOQ	MRP
10-399	SWIVEL-LOCK FIXED BLADE UTILITY KNIFE	6	468

##### FOLDING KNIFE - FIXED BLADE



HSN CODE: 82081000

PART No.	DESCRIPTION	MOQ	MRP
STHT10424-0	COMPACT FIXED BLADE FOLDING KNIFE	6	418

##### HEAVY DUTY BLADES



HSN CODE: 82081000



PART No.	DESCRIPTION	MOQ	MRP
11-921H	HEAVY DUTY BLADES 3/4" - 19MM	1	1,864
11-983A	KNIFE-BLADE LRG HK BLD 19MM LEN(50MM)100PC	4	1,688
11-921T	10PACK HD UTILITY BLADES	10	188

##### SNAP-OFF KNIFE



HSN CODE: 82081000

OLD PART No.	DESCRIPTION	MOQ	MRP
STHT10276-812	18MM SNAP-OFF KNIFE	20	193

##### DYNAGRIP SNAP-OFF KNIFE



HSN CODE: 82081000

PART No.	DESCRIPTION	MOQ	MRP
STHT10425-812	SNAP-OFF KNIFE DYNAGRIP_25MM	6	596
STHT10418-812	SNAP-OFF KNIFE DYNAGRIP_18MM	6	326

##### SLIDE LOCK SNAP OFF KNIFE



HSN CODE: 82081000

PART No.	DESCRIPTION	MOQ	MRP
STHT10322-800	SLIDE LOCK SNAP OFF KNIFE_9MM	30	65
STHT10323-800	SLIDE LOCK SNAP OFF KNIFE_18MM	20	83

##### BASIC SNAP OFF KNIFE



10-131-S

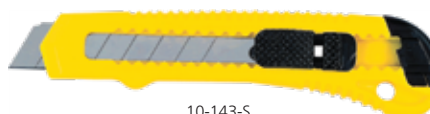

10-143-S

HSN CODE: 82081000

PART No.	DESCRIPTION	MOQ	MRP
10-131-S	KNIFE S/O 9 MM	6	42
10-143-S	KNIFE S/O 18 MM	6	64

##### SNAP OFF KNIFE BLADES



0-11-300

0-11-301



11-301H

0-11-325

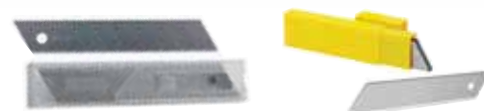

HSN CODE: 82081000



PART No.	DESCRIPTION	MOQ	MRP
0-11-300	10 PACK 9MM SNAP OFF BLADE	10	176
0-11-301	10 PACK 18MM SNAP OFF BLADE	10	188
11-301H	KNIFE BLADE 18MM, LEN 110MM,10 DISP(100PC)	1	1,904
0-11-325	KNIFE-BLADE 25MM, LEN 110MM (10PCS/BOX)	10	612



### PULL CUTTER



HSN CODE: 82081000

PART No.	DESCRIPTION	MOQ	MRP
STHT10355	SINGLE-SIDED PULL CUTTER 1 pk	10	210
STHT10359	DOUBLE-SIDED PULL CUTTER 1 pk	10	210

### SAFETY WRAP CUTTER



HSN CODE: 82081000

PART No.	SIZE	MOQ	MRP
STHT10244	SAFETY WRAP CUTTER 7"/179MM	6	286
STHT10245	SAFETY WRAP CUTTER REPLACEMENT BLADE	6	123

### ASSEMBLY & DEMOLITION HACKSAW



HSN CODE: 82021010

PART No.	SIZE	MOQ	MRP
0-15-218	HACKSAW-JUNIOR 150MM-6 BLADE LEN 254MM-10"	10	504
15-166	HACKSAW-STLFRM,450MM-17 3/4,BLD-305MM-12"	6	1,598
15-265-23	RUBBERGRIP HACKSAW ADJST FRM, BLD254MM-10"	6	1,067

### MINI HACKSAW



0-20-807

HSN CODE: 82081010

PART No.	DESCRIPTION	MOQ	MRP
0-20-807	MINI HACKSAW	6	217

### GLASS CUTTER



HSN CODE: 82079090

PART No.	DESCRIPTION	MOQ	MRP
14-125	GLASS CUTTER, OVERALL LENGTH 130MM 5 1/8"	24	258

### BOLT CUTTER



HSN CODE: 82034090

PART No.	DESCRIPTION	MOQ	MRP
14-308-23	BOLT CUTTER, OVERALL LENGTH 203MM-8"	6	578
14-312-23	BOLT CUTTER, OVERALL LENGTH 305MM-12"	6	1,097
14-314-23	BOLT CUTTER, OVERALL LENGTH 355MM-14"	6	1,180
14-318-23	BOLT CUTTER-TUBULAR HANDLE, 457MM-18"	6	1,527
14-324-23	BOLT CUTTER-TUBULAR HANDLE, 609MM-24"	2	1,964
14-330-23	BOLT CUTTER-TUBULAR HANDLE,762MM-30"	1	2,742
14-336-23	BOLT CUTTER-TUBULAR HANDLE, 914MM-36"	1	4,008

### AVIATION SNIPS



HSN CODE: 82033000

PART No.	DESCRIPTION	MOQ	MRP
2-14-562	AV SNIPS LEFT CUT BI-MAT 254MM	6	1,086
2-14-563	AV SNIPS STRAIGHT CUT BI-MAT 254MM	6	1,143
2-14-564	AV SNIPS RIGHT CUT BI-MAT 254MM	6	1,143

### CABLE CUTTER



HSN CODE: 82034090

PART No.	DESCRIPTION	MOQ	MRP
84-258-23	CABLE CUTTER, LEN 250MM-10, MAX 60SQ. MM	6	976





**MAXSTEEL SNIP**



HSN CODE: 82033000

PART No.	DESCRIPTION	MOQ	MRP
2-14-556	TIN SNIPS STRAIGHT BI-MAT 250MM	6	1,046

**TINSNIPS W/O SPRING**



HSN CODE: 82033000

PART No.	DESCRIPTION	MOQ	MRP
14-163	TINSNIPS W/O SPRING, 200MM-8"	6	1,091
14-164	TINSNIPS W/O SPRING, 250MM-10	6	1,252
14-165	TINSNIPS W/O SPRING, 300MM-12	6	1,670
14-166	TINSNIPS W/O SPRING, 350MM-14	6	2,230

**PIPE CUTTER**



HSN CODE: 82032000

PART No.	CAPACITY	MOQ	MRP
14-442	42MM DIAMETER	1	1,296

**TUBING CUTTER H/D**



HSN CODE: 82034010

PART No.	SIZE	MOQ	MRP
93-021-22	3MM-1/8 TO 28MM-1 1/4	1	1,566

**SMOOTH PLANE**



HSN CODE: 82053000

PART No.	DESCRIPTION	MOQ	MRP
STHT12163-8	# 3 SMOOTH PLANE 9 1/4"	1	1,660
STHT12164-8	# 4 SMOOTH PLANE 9 3/4"	1	1,660
STHT12165-8	# 5 SMOOTH PLANE 14"	1	2,009



**HEAVY DUTY BI-MATERIAL HANDSAW**



HSN CODE: 84679900

PART No.	DESCRIPTION	MOQ	MRP
STHT20373-LA	HEAVY DUTY BI-MATERIAL HANDSAW 15" (380MM)	6	797
STHT20374-LA	HEAVY DUTY BI-MATERIAL HANDSAW 18" (450MM)	6	879
STHT20375-LA	HEAVY DUTY BI-MATERIAL HANDSAW 20" (500MM)	6	959
STHT20376-LA	HEAVY DUTY BI-MATERIAL HANDSAW 22" (600MM)	6	1,064

**PRUNING SHEAR**



HSN CODE: 82015000

PART No.	DESCRIPTION	MOQ	MRP
14-302-23	SHEARS-PRUNING BYPASS 8INCH	6	473

**HEDGE SHEAR**



HSN CODE: 82016000

PART No.	DESCRIPTION	MOQ	MRP
STHT74995-8	8INCH HEDGE SHEARS	1	1,397



### STRIKING TOOLS

#### HAMMERS

##### BALL PEIN HAMMER



HSN CODE: 82052000

PART No.	DESCRIPTION	MOQ	MRP
54-106	BALL PEIN HAMMER 110GMS-4 OZ	6	269
54-107	BALL PEIN HAMMER 220GMS-8 OZ	6	327
54-111	BALL PEIN HAMMER 340GMS-12 OZ	6	385
54-114	BALL PEIN HAMMER 450GMS-16 OZ	6	496
54-115	BALL PEIN HAMMER 680GMS-24 OZ	4	642
54-118	BALL PEIN HAMMER 900GMS-32 OZ	4	758

##### WOOD/FIBRE GLASS NAIL HAMMER

51-159



51-186



HSN CODE: 82052000

PART No.	DESCRIPTION	MOQ	MRP
51-159	WOOD HANDLE NAIL HAMMER 450GMS-16"	6	467
51-186	FIBREGLASS NAIL HAMMER 450GMS-16"	6	502
51-187	FIBREGLASS NAIL HAMMER 560GMS-20"	6	595

##### CLAW HAMMER STEEL SHAFT



HSN CODE: 82052000

PART No.	DESCRIPTION	MOQ	MRP
51-152	CLAW HAMMER STEEL SHAFT 220GMS-8"	6	327
51-158	CLAW HAMMER STEEL SHAFT 560GMS-20"	6	560

##### CAMP AXE STEEL SHAFT



HSN CODE: 82055990

PART No.	SIZE	MOQ	MRP
54-105	CAMP AXE STEEL SHAFT 560GMS-20 OZ	6	665

##### SOFT FACE HAMMER



HSN CODE: 82052000

PART No.	SIZE	MOQ	MRP
57-054	SOFT FACE HAMMER WWOOD HANDLE, 22MM	6	1,095
57-055	SOFT FACE HAMMER WWOOD HANDLE, 28MM	6	1,252
57-056-23	SOFT FACE HAMMER WWOOD HANDLE, 35MM	6	1,689
57-057	SOFT FACE HAMMER WWOOD HANDLE, 45MM	6	2,889

##### SLEDGE HAMMER



HSN CODE: 82052000

PART No.	DESCRIPTION	MOQ	MRP
95IB56400E	SLEDGE HAMMER HICKORY HANDLE 1.36KGS-3LB	4	874
95IB56401E	SLEDGE HAMMER HICKORY HANDLE 1.81KGS-4LB	4	1,451
95IB56608E	SLEDGE HAMMER HICKORY HANDLE 3.62 KGS-8LB	4	2,446
95IB56612E	SLEDGE HAMMER HICKORY HANDLE 5.44 KGS-12LB	2	3,261

##### COMPO CAST HAMMER



HSN CODE: 82052000

PART No.	DESCRIPTION	MOQ	MRP
57-531	HAMMER COMPO CAST STD SOFTFACE, 510GM-18Oz	4	3,270
57-532	HAMMER COMPO CAST STD SOFTFACE, 595GM-21Oz	4	3,494

##### RUBBER MALLET



HSN CODE: 82052000

PART No.	DESCRIPTION	MOQ	MRP
STHT57527-8	RUBBER MALLET HAMMER 450GM-16Oz	6	341
STHT57528-8	RUBBER MALLET HAMMER 680GM-24Oz	6	396

##### CHISELS & PUNCHES COLD CHISEL/CENTER PUNCH

STHT16290-8



16-228



HSN CODE: 82073000

PART No.	DESCRIPTION	MOQ	MRP
STHT16290-8	COLD CHISEL 7/8"/22MM	3	620
16-228	CENTER PUNCH, 8MM-5/16 X 115MM-4 1/2	3	205

##### PUNCH KIT

16-226



16-299



HSN CODE: 82073000

PART No.	DESCRIPTION	MOQ	MRP
16-226	6 PC PUNCH KIT	2	1,072
16-299	12 PC PUNCH & CHISEL KIT	3	2,214

##### WOOD CHISEL SET

16-089



STHT16120-8



HSN CODE: 82053000

PART No.	DESCRIPTION	MOQ	MRP
16-089	WOOD CHISEL SET, 3 PCS	5	775
STHT16120-8	WOOD CHISEL 1/4 SET 6-PIECE	12	1,346

**WOKHOLDING & CLAMPS**

**CLAMPS**

**MAXSTEEL "G" CLAMP**



HSN CODE: 82057000

PART No.	DESCRIPTION	MOQ	MRP
0-83-031	MAXSTEEL "G" CLAMP 25MM/1"	10	205
0-83-032	MAXSTEEL "G" CLAMP 50MM/2"	10	374
0-83-033	MAXSTEEL "G" CLAMP 75MM/3"	6	502
0-83-034	MAXSTEEL "G" CLAMP 100MM/4"	6	700
0-83-035	MAXSTEEL "G" CLAMP 150MM/6"	4	1,154

**BENCH VICE**

**BENCH VICE**

**MAXSTEEL® BENCH VISE - LIGHT DUTY**



HSN CODE: 82057000

PART No.	DESCRIPTION	MOQ	MRP
1-83-065	MAXSTEEL® BENCH VISE - LIGHT DUTY	1	3,736

**HEAVY DUTY BENCH VICE**



HSN CODE: 82057000

PART No.	DESCRIPTION	MOQ	MRP
1-83-066	HEAVY DUTY BENCH VICE 4"	1	6,867
1-83-067	HEAVY DUTY BENCH VICE 5"	1	9,767
1-83-068	HEAVY DUTY BENCH VICE 6"	1	12,360

**TRIGGER CLAMP**

**TRIGGER CLAMP**

**METAL SPRING CLAMP**

9-83-079

9-83-080



HSN CODE: 82057000

PART No.	DESCRIPTION	MOQ	MRP
9-83-079	25MM/1" METAL SPRING CLAMP(MERCH X50)	50	155
9-83-080	50MM/2" METAL SPRING CLAMP(MERCH X30)	30	264

**FATMAX TRIGGER CLAMP - SMALL / MEDIUM**



HSN CODE: 82057000

PART No.	DESCRIPTION	MOQ	MRP
FMHT0-83231	FM S TRIGGER CLAMP	6	385
FMHT0-83232	FM M TRIGGER CLAMP - 150MM	3	946
FMHT0-83233	FM M TRIGGER CLAMP - 300MM	3	979

**FATMAX TRIGGER CLAMP - LARGE**



HSN CODE: 82057000

PART No.	DESCRIPTION	MOQ	MRP
FMHT0-83234	FM L TRIGGER CLAMP - 150MM	4	1,704
FMHT0-83235	FM L TRIGGER CLAMP - 300MM	4	1,913
FMHT0-83236	FM L TRIGGER CLAMP - 600MM	4	2,384
FMHT0-83237	FM L TRIGGER CLAMP - 900MM	2	2,583

**FATMAX TRIGGER CLAMP - XTRA LARGE**



HSN CODE: 82057000

PART No.	DESCRIPTION	MOQ	MRP
FMHT0-83238	FM XL TRIGGER CLAMP - 150MM	4	2,747
FMHT0-83239	FM XL TRIGGER CLAMP - 300MM	4	2,857
FMHT0-83240	FM XL TRIGGER CLAMP - 600MM	4	2,967
FMHT0-83241	FM XL TRIGGER CLAMP - 900MM	2	3,132
FMHT0-83242	FM XL TRIGGER CLAMP - 1250MM	2	4,176

**F-CLAMP**

**F-CLAMP**

**HEAVY DUTY F- CLAMP**



HSN CODE: 82057000

PART No.	DESCRIPTION	MOQ	MRP
FMHT0-83244	HEAVY DUTY CLUTCH LOCK F CLAMP 200MM	4	1,484
FMHT0-83245	HEAVY DUTY CLUTCH LOCK F CLAMP 400MM	2	1,671
FMHT0-83246	HEAVY DUTY CLUTCH LOCK F CLAMP 600MM	2	1,802
FMHT0-83247	HEAVY DUTY CLUTCH LOCK F CLAMP 800MM	2	1,968

### STORAGE TOOL TROLLEY 7 DRAWER ROLLER CABINET



DRAWER DIMENSIONS	
Top 5	570x410x75 mm
6th	570x410x154 mm
Bottom	540x408x105 mm

HSN CODE: 73269099

PART No.	SIZE	MOQ	MRP
93-547-23ID	674x459x857MM	1	58,815

### 7 DRAWER ROLLER CABINET



DRAWER DIMENSIONS	
Top 4	540x408x72 mm
Bottom 3	540x408x105 mm

HSN CODE: 73269099

PART No.	SIZE	MOQ	MRP
STST74306-8	680x459x900MM	1	46,302

### 7 DRAWER ROLLER CABINET



DRAWER DIMENSIONS	
Top 4	579x407x39 mm
Mid 2	579x407x91.5 mm
Bottom	579x407x197 mm

HSN CODE: 73269099

PART No.	SIZE	MOQ	MRP
93-557L	668x458x885MM	1	41,793

### 6 DRAWER ROLLER CABINET



DRAWER DIMENSIONS	
Top 4	571.8x397.4x47.2mm
Bottom 2	571.8x397.4x122.3mm

HSN CODE: 73269099

PART No.	SIZE	MOQ	MRP
STST98182-1	696x460x859MM	1	45,755



### 4 DRAWER ROLLER CABINET



DRAWER DIMENSIONS	
536x410x75.5 mm	

HSN CODE: 73269099

PART No.	SIZE	MOQ	MRP
STMT99069-8	698x477x973MM	1	41,793



**DEWALT TSTAK**  
**DEWALT TSTAK**  
**DEWALT TSTAK SHALLOW BOX**



Dimensions	Weight Capacity
44 x 33.3 x 16.2 cm	30 Kg

HSN CODE: 73269099

PART No.	DESCRIPTION	MOQ	MRP
DWST83345-1	DEWALT TSTAK SHALLOW BOX	1	4,176

**DEWALT TSTAK SHALLOW BOX LONG HANDLE**



Dimensions	Weight Capacity
44 x 33.2x 18.3 cm	30 Kg

HSN CODE: 73269099

PART No.	DESCRIPTION	MOQ	MRP
DWST83344-1	DEWALT TSTAK SHALLOW BOX LONG HANDLE	1	5,055

**DEWALT TSTAK DEEP BOX**



Dimensions	Weight Capacity
44 x 33.3x 30.2 cm	30 Kg

HSN CODE: 73269099

PART No.	DESCRIPTION	MOQ	MRP
DWST83346-1	DEWALT TSTAK DEEP BOX	1	3,517

**DEWALT TSTAK DEEP BOX LONG HANDLE**



Dimensions	Weight Capacity
44 x 33.3x 32.3 cm	30 Kg

HSN CODE: 73269099

PART No.	DESCRIPTION	MOQ	MRP
DWST83343-1	DEWALT TSTAK DEEP BOX LONG HANDLE	1	4,176

**TSTAK DEEP DRAWER UNIT 1**



Dimensions	Weight Capacity
43 x 31.5 x 18 cm	7.5kg per drawer

HSN CODE: 73269099

PART No.	DESCRIPTION	MOQ	MRP
DWST1-70705	TSTAK DEEP DRAWER UNIT 1	1	4,176

**TSTAK DRAWER UNIT 2**



Dimensions	Weight Capacity
43 x 31.5 x 17.5 cm	7.5kg per drawer

HSN CODE: 73269099

PART No.	DESCRIPTION	MOQ	MRP
DWST1-70706	TSTAK DRAWER UNIT 2	1	4,615

**DEWALT TSTAK ORGANISER**



Dimensions	Weight Capacity
44 x 33.2 x 11.9 cm	20kg

HSN CODE: 73269099

PART No.	DESCRIPTION	MOQ	MRP
DWST82968-1	DEWALT TSTAK ORGANISER	1	3,846

**TSTAK OPEN TOTE**



Dimensions	Volume Capacity
44 x 32 x 27.5 cm	26.5L

HSN CODE: 73269099

PART No.	DESCRIPTION	MOQ	MRP
DWST1-71228	TSTAK OPEN TOTE	1	2,583

**DEWALT TSTAK MOBILE STORAGE BOX**

NEW  
 10% OFF  
 10/10/2023  
 10/10/2023



Dimensions	Weight Capacity
51.2 x 43.5 x 63.5 cm	50 Kg

HSN CODE: 73269099

PART No.	DESCRIPTION	MOQ	MRP
DWST83347-1	DEWALT TSTAK MOBILE STORAGE BOX	1	7,031

**TSTAK TROLLEY**

NEW  
 10% OFF  
 10/10/2023  
 10/10/2023



Dimensions	Weight Capacity
58 x 54 x 104.3 cm	100kg

HSN CODE: 73269099

PART No.	DESCRIPTION	MOQ	MRP
DWST1-71196	TSTAK TROLLEY	1	14,831

**TSTAK CART**

NEW  
 10% OFF  
 10/10/2023  
 10/10/2023



Dimensions	Weight Capacity
48.6 x 43.6 x 18.1 cm	100kg

HSN CODE: 73269099

PART No.	DESCRIPTION	MOQ	MRP
DWST1-71229	TSTAK CART	1	5,933

**PORTABLE STORAGE**

**PORTABLE STORAGE**

**ESSENTIAL 3IN1 ROLLING WORKSTATION**

NEW  
 10% OFF  
 10/10/2023  
 10/10/2023



Dimensions	Weight Capacity
47.5 x 63 x 28.3 cm	20 kg

HSN CODE: 73269099

PART No.	DESCRIPTION	MOQ	MRP
STST1-80151	ESSENTIAL 3IN1 ROLLING WORKSTATION	1	4,780

**ESSENTIAL JOB CHEST**

NEW  
 10% OFF  
 10/10/2023  
 10/10/2023



Dimensions	Weight Capacity
67 x 34.5 x 40.5 cm	30 kg

HSN CODE: 73269099

PART No.	DESCRIPTION	MOQ	MRP
STST1-80150	ESSENTIAL JOB CHEST	2	4,944



**CANTILEVER TOOL BOX (5 TRAY)**



HSN CODE: 73269099

PART No.	SIZE	MOQ	MRP
1-94-738	5 TRAY METAL TOOL BOX	1	3,594
STST83397-1	STANLEY PLASTIC CANTILEVER TOOL BOX	4	2,528

**JUMBO TOOL BOX - HEAVY DUTY**



HSN CODE: 73269099

PART No.	SIZE	MOQ	MRP
1-92-905	PLASTIC TOOL BOX 410MM-16"	6	1,747
1-92-906	PLASTIC TOOL BOX 485MM-19"	6	2,330
1-92-908	PLASTIC TOOL BOX 560MM-22"	3	3,844

**ESSENTIAL TOOLBOX WITH METAL LATCH**



HSN CODE: 39231090

PART No.	SIZE	MOQ	MRP
STST1-75515	12.5" ESSENTIAL TOOLBOX WITH METAL LATCH	6	667
STST1-75518	16" ESSENTIAL TOOLBOX WITH METAL LATCHES	6	1,066
STST1-75521	19" ESSENTIAL TOOLBOX WITH METAL LATCHES	6	1,442

**BASIC TOOL BOX WITH ORGANIZER**



HSN CODE: 73102990

PART No.	SIZE	MOQ	MRP
1-71-948	13" BASIC TOOL BOX WITH ORGANIZER	12	385
1-71-949	16" BASIC TOOL BOX WITH ORGANIZER	12	688
1-71-950	19" BASIC TOOL BOX WITH ORGANIZER	9	967
1-71-951	22" BASIC TOOL BOX WITH ORGANIZER	6	1,619

**ORGANIZER  
SORTMASTER ORGANIZER**



HSN CODE: 73269099

PART No.	SIZE	MOQ	MRP
STST1-70720	SORTMASTER LIGHT ORGANIZER (29.5x6.5x21.5CM)	6	572
1-97-483	SORTMASTER JUNIOR ORGANIZER (37.5x6.7x29.2CM)	6	793
1-94-745	SORTMASTER 90D ANGLE ORGANIZER (43x9x33CM)	6	1,128

**POLY-ORGANIZER**



HSN CODE: 73269099

PART No.	SIZE	MOQ	MRP
STST73822-8	POLY SMALL ORGANIZER	18	292
STST73823-8	POLY MEDIUM ORGANIZER	16	525
STST73824-8	POLY LARGE ORGANIZER	10	851

**SOFT STORAGE  
NYLON TOOL BAG, WATER PROOF**



HSN CODE: 42022290

93-222

PART No.	SIZE	MOQ	MRP
93-222	NYLON TOOL BAG, WATER PROOF 252MM-10"	1	670
93-223	NYLON TOOL BAG, WATER PROOF, 305MM-12"	1	2,066
93-224	NYLON TOOL BAG, WATER PROOF, 460MM-18"	1	2,405
93-225	NYLON TOOL BAG, WATER PROOF, 660MM-26"	1	3,407

**OPEN MOUTH TOOL BAG**



HSN CODE: 42022290

PART No.	SIZE	MOQ	MRP
STST516126	OPEN MOUTH BAG 16"	4	2,300
STST512114	OPEN MOUTH BAG 12"	4	908

**STANLEY BACK PACK**



HSN CODE: 73269099

PART No.	DESCRIPTION	MOQ	MRP
STST1-72335	STANLEY BACK PACK	6	3,931

**FATMAX BACKPACK**



HSN CODE: 73269099

PART No.	DESCRIPTION	MOQ	MRP
1-95-611	FATMAX BACKPACK	2	5,660

**BACKPACK ON WHEELS**



HSN CODE: 42022290

PART No.	DESCRIPTION	MOQ	MRP
FMST514196	BACKPACK ON WHEELS	2	8,123

**FATMAX TOOL VEST**



HSN CODE: 42022290

PART No.	DESCRIPTION	MOQ	MRP
FMST1-71181	FATMAX TOOL VEST	2	3,727

**TOOL APRON**



HSN CODE: 42022290

PART No.	DESCRIPTION	MOQ	MRP
STST511304	Tool Apron	4	1,817





**TOOL KITS**

**108 PC HAND TOOL KIT**



HSN CODE: 84679900

PART No.	DESCRIPTION	MOQ	MRP
BMT108C	BLACK+DECKER HAND TOOL KIT 108 PC	3	2,753

- 1 PC- Stubby Adjustable Wrench Carbon Steel,
- 1 PC- 160mm Long Nose Pliers Carbon Steel,
- 1 PC- 160mm Combination Pliers Carbon Steel,
- 1 PC- 9-LED Flashlight,
- 1 PC- 18mm Snap-Off Utility Knife,
- 1 PC- 3m Measuring Tape, MID,
- 1 PC- 8oz Claw Hammer, 1 PC- 140mm Tester, VDE,
- 1 PC- Insulated Tape, 0.13x18mmx10m,
- 6 PC- 1/4inch Dr. Socket, CrV, Chrome Plated, 5-6-7-8-9-10mm,
- 1 PC- 1/4inch Dr. Bit Adapter,
- 3 PC- Masonry Drill,
- 1 PC- 150mm Mini Hacksaw,
- 8 PC- Hex Key: 1.5-2-2.5-3-4-5-5.5-6mm,
- 10 PC- 25mm Bits, CrV, Sand Blasted,
- 1 PC- Stubby Ratchet Screwdriver,
- 1 PC- Precision Bit Holder,
- 12 PC- 4x28mm Precision Screwdriver, CrV,
- 56 PC- Screw 3x30, 4x35 and 5x50. S Plug 5x30, 6x30,8x35

**126 PC HAND TOOL KIT**



HSN CODE: 84679900

PART No.	DESCRIPTION	MOQ	MRP
BMT126C	BLACK+DECKER HAND TOOL KIT 126 PC	3	3,177

- 1 PC 10inch Hand Saw with Carbon Steel Blade,
- 10 PCs Bit Set Bits size: slotted: 1/8 3/16 1/4 PH: Ph1 Ph2 Torx: T15 T20Hex:
- 1/8 5/32 Adapter,
- 1 PC 9LED Torch light,
- 4 PCs Precision Screwdriver Size: PH1,PH0, slotted 1.6mm, 2.0mm,
- 1 PC 5m Tape,
- 1 PC 3m Measurer Tape,
- 1 PC 8 Adjustable Wrench,
- 8 PCs Hex key :1.5-2-2.5-3-4-5-5.5-6mm,
- 1 PC 8oz Claw Hammer,
- 1 PC 6inch long Nose Pliers,
- 1 PC 6inch combination pliers,
- 1 PC Bit Handle with A3 steel,
- 2 PCs Screwdriver PH2x100mm, SL6x100mm,
- 1 PC 140mm Tester,
- 1 PC 18mm Knife,
- 9 PCs 1/4 dr Socket 5,6,7,8,9,10,11,12,13mm with Carbon Steel,

**MIXED TOOL SETS**

**154 PC HAND TOOL KIT**



HSN CODE: 84679900

PART No.	DESCRIPTION	MOQ	MRP
BMT154C	BLACK+DECKER HAND TOOL KIT 154 PC	3	4,024

- 1 PC 250mm Water pump Pliers with carbon steel,
- 1 PC 225mm Torpedo Level,
- 1 box Hardware Assortment,
- 1 PC 25mm Bits with CRV,
- 1 PC Bit Driver, Two Tone Handle,
- 1 set Screwdriver (SL5x75, SL6x100mm+D7 PH1x75, PH2x100mm with 6150CRV blade),
- 1 set Hex Key (1.5-10mm),
- 1 PC 5m x 19mm Measuring Tape,
- 1 PC 1/4" "Dr. Ratchet,
- 1 PC 1/4" "Dr. Socket(5-13mm with carbon steel),
- 1 PC 160mm Diagonal Pliers with carbon steel,
- 1 PC 160mm Combination Pliers with carbon steel,
- 1 PC 12oz Claw Hammer with carbon steel,
- 1 PC 18mm Snap-off Utility Knife, 1 PC 18mm Snap-off Utility Blades,



**SCREWDRIVERS**

**MULTIBIT RATCHETING SD WITH 10 BITS**



HSN CODE: 82054000

PART No.	DESCRIPTION	MOQ	MRP
BDHT68127	MULTIBIT RATCHETING SD WITH 10 BITS	12	360

**PHILIPS SCREWDRIVER**



HSN CODE: 82054000

PART No.	DESCRIPTION	MOQ	MRP
BDHT62296	SCREWDRIVER PH1 X 100MM	12	93
BDHT62297	SCREWDRIVER PH2 X 150MM	12	116

**SCREWDRIVER STANDARD**



HSN CODE: 82054000

PART No.	DESCRIPTION	MOQ	MRP
BDHT62298	SCREWDRIVER STANDARD 5 X 100MM	12	93
BDHT62299	SCREWDRIVER STANDARD 6.5 X 150MM	12	116

**8PCS HEX KEY SET**



HSN CODE: 82041120

PART No.	DESCRIPTION	MOQ	MRP
BDHT81593	8PCS HEXKEY SET	6	185

**HALF-OPEN CAULKING GUN**



HSN CODE: 84672900

PART No.	DESCRIPTION	MOQ	MRP
BDHT81570	HALF-OPEN CAULKING GUN	24	357

**PLIERS**

**PLIERS**

**DIAGONAL CUTTING PLIERS**



HSN CODE: 82032000

PART No.	DESCRIPTION	MOQ	MRP
BDHT81584	160MM DIAGONAL CUTTING PLIERS	6	362

**LONG NOSE PLIERS**



HSN CODE: 82032000

PART No.	DESCRIPTION	MOQ	MRP
BDHT81586	160MM LONG NOSE PLIERS	6	360

**CUTTING TOOLS**

**CUTTING TOOLS**

**METAL HACKSAW**



HSN CODE: 82029990

PART No.	DESCRIPTION	MOQ	MRP
BDHT20344	300MM METAL HACKSAW	6	845

**MITRE BOX WITH SAW**



HSN CODE: 73182990

PART No.	DESCRIPTION	MOQ	MRP
BDHT20346	MITRE BOX WITH SAW	6	1,022

**UNIVERSAL SCISSORS**



HSN CODE: 82130000

PART No.	DESCRIPTION	MOQ	MRP
BDHT81569	UNIVERSAL SCISSORS	24	274



**MEASURING TOOLS**  
**LEVELS**

**BOX BEAM LEVEL**



HSN CODE: 90178090

PART No.	DESCRIPTION	MOQ	MRP
BDHT43188	BOX BEAM LEVEL 40CM	40	424
BDHT43189	BOX BEAM LEVEL 60CM	40	520
BDHT43190	BOX BEAM LEVEL 100CM	40	711



**FILES**  
**FILES**



HSN CODE: 82031000

PART No.	DESCRIPTION	MOQ	MRP
BDHT22144	200MM 2ND CUT FLAT FILE	12	300
BDHT22145	200MM 2ND CUT ROUND FILE	12	268
BDHT22146	200MM 2ND CUT HALF ROUND FILE	12	323
BDHT22147	200MM 2ND CUT TRIANGLE FILE	12	300

**FILE SET**



HSN CODE: 82031000

PART No.	DESCRIPTION	MOQ	MRP
BDHT22148	6 PCS NEEDLE FILE SET	10	432

**STRIKING TOOLS**

**STRIKING TOOLS**

**FIBERGLASS HANDLE DIN HAMMER**



HSN CODE: 82052000

PART No.	DESCRIPTION	MOQ	MRP
BDHT51394	300G FIBERGLASS HANDLE DIN HAMMER	6	557
BDHT51395	500G FIBERGLASS HANDLE DIN HAMMER	6	688

**WOOD CHISEL**



HSN CODE: 82053000

PART No.	DESCRIPTION	MOQ	MRP
BDHT16695	12MM WOOD CHISEL	12	268
BDHT16696	18MM WOOD CHISEL	12	284
BDHT16697	25MM WOOD CHISEL	12	297

**STORAGE**

**STORAGE**

**PLASTIC WALL PANEL**



HSN CODE: 73269099

PART No.	DESCRIPTION	MOQ	MRP
BDST73832-8	WALL PANEL B&D	1	2,784

**PORTABLE CABINET**



HSN CODE: 73269099

PART No.	DESCRIPTION	MOQ	MRP
BDST73829-8	BD SMALL PORTABLE CABINET	8	874
BDST73828-8	BD MEDIUM PORTABLE CABINET	8	1,107
BDST73827-8	BD LARGE PORTABLE CABINET	4	1,607

**CANTILEVER TOOLBOX**



HSN CODE: 73269099

PART No.	DESCRIPTION	MOQ	MRP
BST81541	BD PLASTIC CANTILEVER 17"	12	1,049





**STANLEY™**

**DEWALT®**

**BLACK+DECKER™**

**FACOM®**

**PROTO®**

**BRITTOOL**  
*EXPERT*

**STANLEY BLACK & DECKER INDIA PVT. LTD**

28 "Akemps". 3rd Main, 1st Cross, Ashwini Layout,  
Koramangala Intermediate Ring Road, 3rd Main Rd, Bengaluru,  
Karnataka - 560 047 INDIA.

📞 +91 96060 55835 | Helpline No: 1860-425-1111

✉️ [sbd-customercommunications@sbdinc.com](mailto:sbd-customercommunications@sbdinc.com)

CAT-CPG0007